



LAYHER UNI WIDE INSTRUCTIONS FOR ASSEMBLY AND USE

SAFETY STRUCTURE P2,
SAFETY STRUCTURE P2 WITH UNI TELESCOPING GUARDRAIL
AND SAFETY STRUCTURE P2 SAFETY^{PLUS}

DIN EN 1004-2-DE



Edition 09.2024

Ref. No. 8107.339

Mobile Working Platforms
According to DIN EN 1004-1:2021
Working platform 1.50x2.85 m

Max. working height:
Indoors 13.60 m
Outdoors 9.60 m

Permissible load capacity: 2.0 kN/m²
on max. one working level
(Load class 3 according to
DIN EN 1004-1:2021)



CONTENTS



ROLLING TOWERS WITH SAFETY STRUCTURE P2

1. Introduction.....	4
2. General instructions for assembly and use.....	5
3. Assembly variants	
3.1 Rolling Towers with Safety Structure P2	8
3.1.1 Fall protection measures ...	8
3.1.2 Tower models	10
3.1.3 Parts list	13
3.1.4 Assembly sequence.....	15
3.1.5 Dismantling sequence.....	20
3.1.6 Assembly with brackets... ..	22
4. Castors and mobile beams	54
5. Ballasting	56
6. Ascent via hook-in ladder.....	60
7. Stabiliser attachment	61
8. Wall support and anchoring	62
9. Components of the system.....	63
10. Certificate.....	67

▶ Go directly to page 8



ROLLING TOWERS WITH SAFETY STRUCTURE P2 WITH UNI TELESCOPING GUARDRAIL

1. Introduction.....	4
2. General instructions for assembly and use.....	5
3. Assembly variants	
3.2 Rolling towers with Safety Structure P2 with Uni telescoping guardrail	24
3.2.1 Fall protection measures..	24
3.2.2 Tower models	26
3.2.3 Parts list	28
3.2.4 Assembly sequence.....	29
3.2.5 Dismantling sequence.....	34
3.2.6 Assembly with brackets..	36
4. Castors and mobile beams	54
5. Ballasting	56
6. Ascent via hook-in ladder.....	60
7. Stabiliser attachment	61
8. Wall support and anchoring	62
9. Components of the system.....	63
10. Certificate.....	67

▶ Go directly to page 24



ROLLING TOWERS WITH SAFETY STRUCTURE P2 SAFETY^{PLUS} WITH DOUBLE GUARDRAIL

1. Introduction.....	4
2. General instructions for assembly and use.....	5
3. Assembly variants	
3.3 Rolling towers with Safety Structure P2 SAFETY^{PLUS}	38
3.3.1 Fall protection measures..	38
3.3.2 Tower models.....	40
3.3.3 Parts list	42
3.3.4 Assembly sequence.....	43
3.3.5 Dismantling sequence.....	50
3.3.6 Assembly with brackets..	52
4. Castors and mobile beams.....	54
5. Ballasting	56
6. Ascent via hook-in ladder.....	60
7. Stabiliser attachment	61
8. Wall support and anchoring	62
9. Components of the system.....	63
10. Certificate.....	67

▶ Go directly to page 38



NOTE

The DIN EN 1004-2-de-compliant products or assembly variants shown in these Instructions for Assembly and Use (IAU) may be subject to country-specific regulations. Subject to local regulations, we reserve the right not to supply all of the products illustrated here.

Beyond the currently valid General Terms of Sale of Wilhelm Layher GmbH & Co KG, **no liability** is assumed for damage of whatever nature that has been incurred due to the following reasons:

- ▶ Non-compliance with instructions
- ▶ Improper assembly, and use of the product not for its intended purpose
- ▶ Use of non-original and damaged Layher components
- ▶ Unauthorised structural changes
- ▶ Improperly performed repairs, in particular when non-original Layher spare parts are used
- ▶ Events caused by force majeure (disasters, foreign objects)

The respective user shall ensure on their own responsibility that the points as stated and also the current safety regulations are complied with and that use for the intended purpose is assured.

These Instructions for Assembly and Use must:

- ▶ be available at the place of use of the Mobile Working Platform.
- ▶ be fully respected, including all the specifications they contain, during the assembly, modification and dismantling of the Mobile Working Platform. No modifications to them are permitted, or are permissible only after consultation with the manufacturer.



These instructions cannot cover all the possible applications. If you have any questions about specific applications, please contact your local Layher partner. This contact person will be happy to provide advice and answers to all questions relating to the products, to their use or to specific assembly regulations.

EXPLANATION OF SYMBOLS



Additional information and notes on the assembly, modification, dismantling and use of Mobile Working Platforms and situations in which it is necessary to consult with the manufacturer are indicated by the symbol opposite.



When assembling, modifying, dismantling or using Mobile Working Platforms, failure to observe the present Instructions for Assembly and Use and the applicable work safety regulations may result in a variety of hazards and/or require increased attention on the part of the user. Situations in which such hazards may arise and/or in which users must be required to pay increased attention are indicated by the symbol opposite.



When assembling, modifying, dismantling or using Mobile Working Platforms, failure to observe the present Instructions for Assembly and Use and the applicable work safety regulations may result in risks due to electrical voltages. Situations in which risks due to electrical voltages may arise are indicated by the symbol opposite.



When assembling, modifying, dismantling or using Mobile Working Platforms, failure to observe the present Instructions for Assembly and Use and the applicable work safety regulations may result in risks of falling. Situations in which risks of falling may arise are indicated by the symbol opposite.

1. INTRODUCTION

General

These Instructions for Assembly and Use (IAU) relate to the assembly, modification and dismantling of the **Uni Wide** Mobile Working Platform with Safety Structure P2, Safety Structure P2 with Uni telescoping guardrail and Safety Structure P2 SAFETY^{PLUS} made by Wilhelm Layher GmbH & Co KG, of Gueglingen-Eibensbach, Germany.



Number of persons required for assembly, modification and dismantling: ▶ 2 persons

Caution: Layher Uni Wide may only be assembled, modified and dismantled under the supervision of a person who has been qualified, trained and authorised for operations involving “Mobile Working Platforms”.

2. GENERAL NOTES ON ASSEMBLY AND USE

The Mobile Working Platform may be used for the specified load class in accordance with the stipulations of DIN EN 1004 and taking into account the appropriate sections of the German Ordinance on Industrial Safety and Health (BetrSichV).

The user of the Mobile Working Platform must comply with the following instructions:

- ▶ The user must verify that the selected Mobile Working Platform is suitable for the work to be performed (Section 4 of BetrSichV).
- ▶ The maximum platform height for Mobile Working Platforms in accordance with DIN EN 1004 is
 - inside buildings: 12.00 m.
 - outside buildings: 8.00 m.
- ▶ Assembly, modification or dismantling of the Mobile Working Platform in accordance with the present IAU may only be performed under the supervision of a qualified person or by professionally suitable employees after special instruction. Only the models shown in these IAU may be built and used. The Mobile Working Platform must be inspected before, after or during assembly, but no later than before it is put into service (Section 14 of BetrSichV). During assembly, modification or dismantling, the Mobile Working Platform must be marked with a prohibition sign indicating “no entry” (BetrSichV Annex 1, Para. 3).
- ▶ It is first necessary to check that all parts, auxiliary tools and safety equipment for assembling the Mobile Working Platform are available at the site.
- ▶ All ladder frame joints must always be secured using spring clips.
- ▶ The access hatches must be kept shut whenever they are not in use.
- ▶ Mobile working platforms are not designed to be covered. Mobile working platforms are not designed to be used as side protection.
- ▶ If stipulated, the base must be widened by means, for example, of mobile beams or stabilisers or outriggers and ballast must be installed.
- ▶ Stability **must be ensured during every phase** of assembly and dismantling as well as when the platform is moved. **The necessary ballast weights and/or wall supports** (see corresponding section in these IAU) **must generally be attached before any risk of falling arises.**
- ▶ The adjustable mobile beams may only be inserted in conformity with the IAU. Any ballasting that is required must be installed prior to adjustment in accordance with the ballast specifications given in the section on “Scaffolding models”.
- ▶ To assemble the upper platforms, the individual parts must be passed up from one level to the next. Small quantities of tools and materials can be carried up by the personnel or, failing that, hoisted to the working level using transport ropes.
- ▶ In the case of intermediate platforms used solely for ascent, toe boards can be dispensed with.
- ▶ Working on two or more working levels at the same time is not permitted. In the event of exceptions, the manufacturer must be consulted. When work is being performed on several levels, they must be completely fitted with three-part side protection.
- ▶ Horizontal and vertical loads that can cause the Mobile Working Platform to topple over should be avoided, for example:
 - due to pushing against the side protection (**max. 30 kg**).
 - Due to additional wind loads (tunnel effect of through-type buildings, unclad buildings and corners).
- ▶ Before installation, all parts must be inspected to ensure they are in flawless condition. Only undamaged original parts of the Layher Mobile Working Platforms may be used. Components such as snap-on claws and spigots must be cleaned of dirt after use. Components must be secured against slipping and impacts when transported by truck. Components must be handled in such a way that they are not damaged.
- ▶ The Mobile Working Platforms must not be subjected to any aggressive fluids or gases.
- ▶ Couplers in the structures must be tightened to 50 Nm.

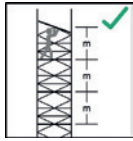

The maximum distance between the platforms must not exceed 2.25 m. Exception: The distance between the assembly level (the ground) and the first platform. The maximum distance permitted here is 3.40 m.



Mobile Working Platforms must be set to the perpendicular using the adjusting spindles or by inserting suitable materials underneath them. The max. permitted inclination is 1% (in horizontal direction = scaffolding length / 100).



Movement is only permitted on sufficiently firm ground with a max. inclination of 4% (approx. 2.5°) in the longitudinal direction or perpendicular to this, and the speed must not exceed normal walking pace (4 km/h). All impacts must be avoided.

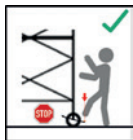

After movement, the wheels must be locked by pressing down the brake lever.

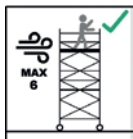

When used in the open air or in open buildings, any **work on the Mobile Working Platform must be stopped immediately if the wind strength exceeds 6 on the Beaufort scale.** At these wind speeds or at the end of a shift, Mobile Working Platforms must be moved to a location where they are protected from the wind or must be or suitable measures must be taken to secure them against toppling over.



A wind strength of more than 6 can be recognized by noticeable difficulty in walking. If possible, Mobile Working Platforms used outside buildings must be securely fastened to the building itself or to another structure. It is recommended that Mobile Working Platforms be anchored if they are left unattended.

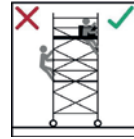

Upward access to Mobile Working Platforms is permitted only on the inside of the scaffolding structure. External access is not permitted.

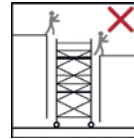

It is not permitted to climb onto and across different Mobile Working Platforms, to climb onto Mobile Working Platforms from other objects or structures or to jump onto deck surfaces.

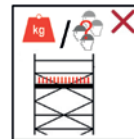

Due to the maximum load-bearing capacity of the structure, there may be a limit to the number of persons allowed to be present on a working level at any given time. This maximum load on the working level due to persons, tools and material must be checked in advance and be limited if necessary.



Failure to respect the maximum load limit can overload the structure and / or cause it to collapse. Serious or fatal injuries are possible.



It is not permitted to increase the platform height by using ladders, boxes or other mechanisms.

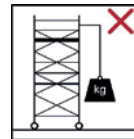

It is not permitted to lift heavy objects by attaching and using lifting gear at Mobile Working Platforms.

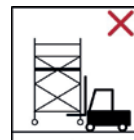

It is not permitted to lift Mobile Working Platforms using mechanical equipment.

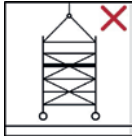

In the standard version, Mobile Working Platforms are not designed to be lifted or suspended.



In certain cases, and following consultation with the manufacturer, it may be possible to reinforce the structure by replacing the appropriate components.



It is not permitted to move the Mobile Working Platform when persons and/or loose objects are present on it.



It is not permissible to stand and move around on unsecured levels/platforms of Mobile Working Platforms.

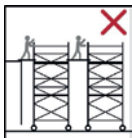

In the standard version, it is not permitted to establish bridges between different Mobile Working Platforms or between Mobile Working Platforms and other objects or structures.



In certain cases, and following consultation with the manufacturer, it may be possible to reinforce the structure by replacing the appropriate components (special construction form) and a special verification of stability or structural calculation must then be performed for this.

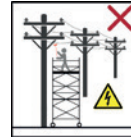

When working with Mobile Working Platforms at or in the vicinity of electrical equipment and overhead cables, it is necessary to respect the following additional instructions.

It is only permissible to assemble and use Mobile Working Platforms if:

- ▶ the equipment is no longer live.
- ▶ the deactivated equipment has been secured against reactivation.
- ▶ the equipment has been checked to ensure that no voltage is present.
- ▶ neighbouring live parts have been secured by means of protective mechanisms.
- ▶ in the case of work performed in the vicinity of overhead electrical cables, an adequate safety distance as specified in VDE 0105-100 can be/is respected.



3.1 ROLLING TOWERS WITH SAFETY STRUCTURE P2

3.1.1 FALL PROTECTION MEASURES

Suitable measures for fall protection must be taken during assembly, modification or dismantling of the scaffolding structure. Safety Structure P2 implements these protective measures in full.

Safety Structure P2

- ▶ Platforms with vertical spacing of 2 m.
- ▶ Safer design with integrated, collective side protection.

Thanks to the platforms, which are assembled 2 m apart, the hand-rails can already be fitted from the level underneath and intermediate rails can be fitted from the secured area of the access hatch, so that when the next platform up is accessed there is already a two-part side protection in place on all sides.

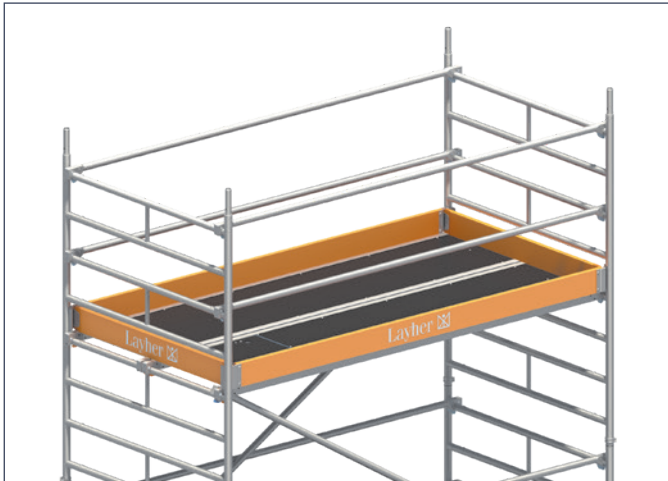



1. Attach the first ladder frame. Attach the Uni assembly hooks and position the second ladder frame in order to fit the guardrails.



2. Swivel the ladder frame with guardrail upwards and fit it in place.

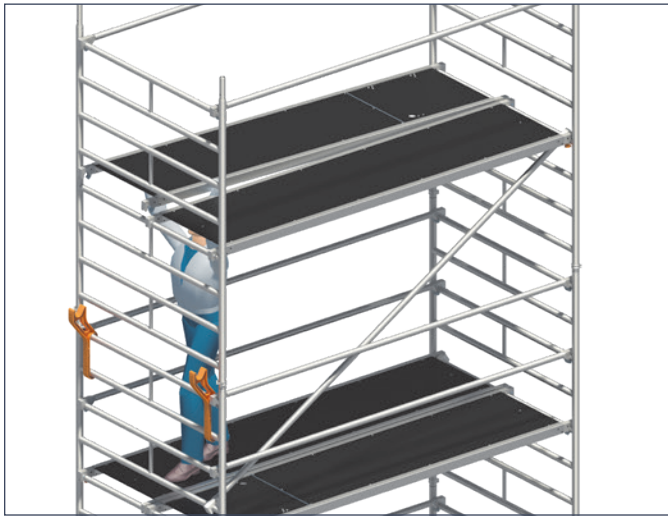

3. Insert diagonal braces, deck and access deck.



4. Assemble the intermediate rails from a secured position in the area of the access hatch.

3.1.2 TOWER MODELS

1402101 – 1402111

For **assembly outdoors**, comply with the height restriction!

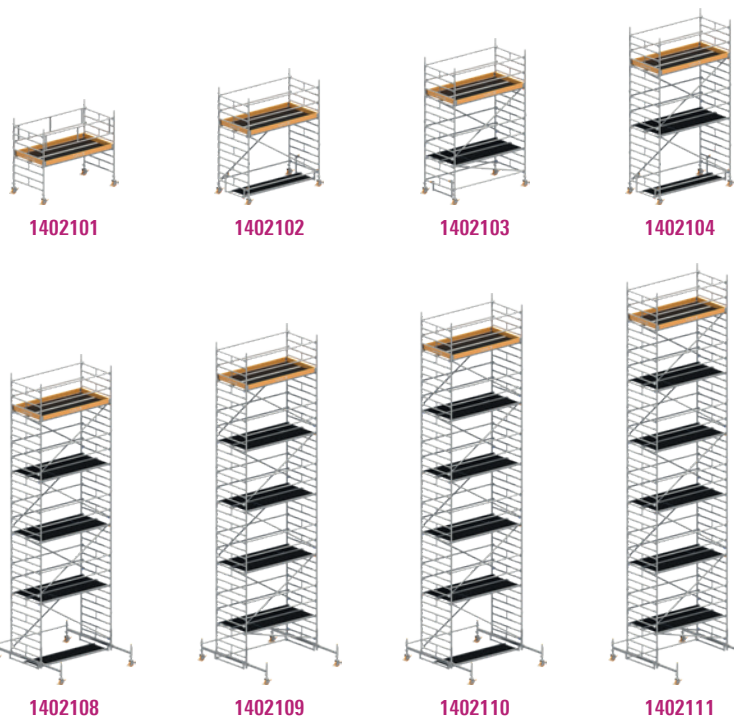
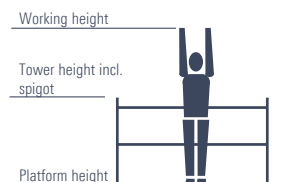

Tower model	1402101	1402102	1402103	1402104	1402105	1402106	1402107	1402108	1402109	1402110	1402111
Working height [m]	3.20	4.20	5.20	6.20	7.20	8.38	9.38	10.38	11.38	12.38	13.38
Tower height [m]	2.43	3.43	4.43	5.43	6.43	7.61	8.61	9.61	10.61	11.61	12.61
Platform height [m]	1.20	2.20	3.20	4.20	5.20	6.38	7.38	8.38	9.38	10.38	11.38
Weight [kg] (without ballast)	128.8	184.6	237.8	276.2	329.4	451.4	511.7	543.2	603.3	634.8	694.9
Ballasting (stated in units)											
Indoors											
Assembly, central*	0	0	0	l1 r1	l1 r1	0	0	0	0	0	0
Assembly, off-centre	X	X	X	X	X	0	0	0	0	0	0
Assembly, off-centre with wall bracing	X	X	X	X	X	0	0	0	0	0	0
Assembly, central with 1 bracket*	X	l0 r10	l0 r10	l0 r12	l0 r12	0	0	0	0	0	X
Assembly, central with 2 brackets*	X	l3 r3	l2 r2	l5 r5	l4 r4	0	0	X	X	X	X
Outdoors											
Assembly, central*	0	l3 r3	l6 r6	l11 r11	l16 r16	0	0	X	X	X	X
Assembly, off-centre	X	X	X	X	X	LO R8	LO R12	X	X	X	X
Assembly, off-centre with wall bracing	X	X	X	X	X	0	0	X	X	X	X
Assembly, central with 1 bracket*	X	l0 r18	l0 r22	l6 r28	X	X	X	X	X	X	X
Assembly, central with 2 brackets*	X	l14 r14	l16 r16	X	X	X	X	X	X	X	X

* For assembly with adjustable mobile beam, the latter must be fully extended. X = not permissible / not possible 0 = no ballast required For ballasting, use Layher ballast weights, Ref. No. 1249.000, of 10 kg each. The weights are fastened quickly and securely at the right place using the handwheel coupler. All heights stated without possible spindle extension! The max. spindle extension of the relevant assembly variants can be found in the corresponding section! **Do not use any liquid or granular ballast substances. The ballast weights must be distributed evenly to all ballasting fixing points.**

Example: l2, r2 → Fasten 2 ballast weights of 10 kg each to the ladder frame on its left-hand side, and 2 ballast weights of 10 kg each on its right-hand side.
 L6, R16 → Fasten 6 ballast weights of 10 kg each to the mobile beam on its left-hand side, and 6 ballast weights of 10 kg each on its right-hand side.
 In the case of off-centre assembly, r and R always relate to the side facing away from the tower; l and L relate to the side facing the tower.

1402122 – 1402131 with stabilisers, extendible

For **assembly outdoors**, comply with the height restriction!

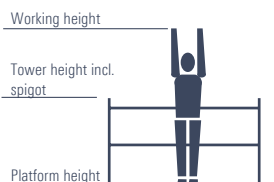

1402122

1402123

1402124

1402125



1402126

1402127

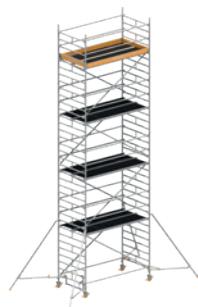

1402128

1402129

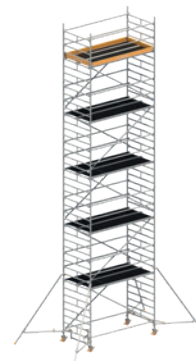

1402130

1402131

Tower model	1402122	1402123	1402124	1402125	1402126	1402127	1402128	1402129	1402130	1402131
Working height [m]	4.20	5.20	6.20	7.20	8.20	9.20	10.20	11.20	12.20	13.20
Tower height [m]	3.43	4.43	5.43	6.43	7.43	8.43	9.43	10.43	11.43	12.43
Platform height [m]	2.20	3.20	4.20	5.20	6.20	7.20	8.20	9.20	10.20	11.20
Weight [kg] (without ballast)	206.7	283.2	298.3	374.8	389.7	466.2	481.3	557.8	572.9	649.4
Ballasting (stated in units)										
Indoors										
Assembly, central	0	0	0	0	0	0	0	0	0	0
Assembly, off-centre	0	0	0	0	LO R2	LO R2	LO R2	LO R2	LO R4	LO R4
Assembly, off-centre with wall bracing	0	0	0	0	0	0	0	0	0	0
Outdoors										
Assembly, central	0	0	0	0	0	0	X	X	X	X
Assembly, off-centre	0	LO R4	LO R4	LO R10	LO R14	LO R18	X	X	X	X
Assembly, off-centre with wall bracing	0	0	0	0	0	0	X	X	X	X

X = not permissible / not possible 0 = no ballast required For ballasting, use Layher ballast weights, Ref. No. 1249.000, of 10 kg each. The weights are fastened quickly and securely at the right place using the handwheel coupler. All heights stated without possible spindle extension! The max. spindle extension of the relevant assembly variants can be found in the corresponding section! **Do not use any liquid or granular ballast substances.**

The ballast weights must be distributed evenly to all ballasting fixing points.

Example: L2, r2 → Fasten 2 ballast weights of 10 kg each to the ladder frame on its left-hand side, and 2 ballast weights of 10 kg each on its right-hand side.
L6, R16 → Fasten 6 ballast weights of 10 kg each to the mobile beam on its left-hand side, and 16 ballast weights of 10 kg each on its right-hand side.
In the case of off-centre assembly, r and R always relate to the side facing away from the tower, l and L relate to the side facing the tower.

1402146 – 1402151 with stabilisers, 5 m

For **assembly outdoors**, comply with the height restriction!

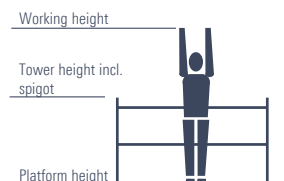

1402146



1402147



1402148

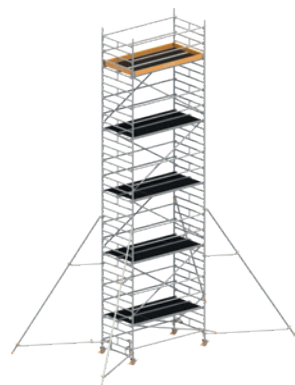

1402149

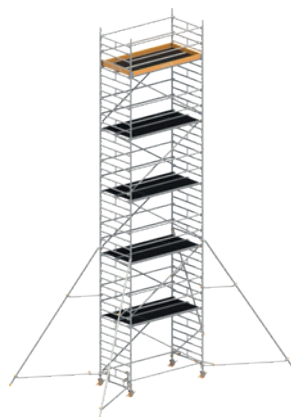

1402150

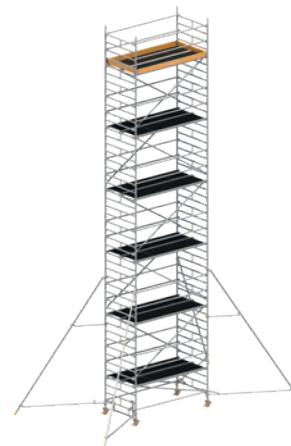

1402151

Tower model	1402146	1402147	1402148	1402149	1402150	1402151
Working height [m]	8.20	9.20	10.20	11.20	12.20	13.20
Tower height [m]	7.43	8.43	9.43	10.43	11.43	12.43
Platform height [m]	6.20	7.20	8.20	9.20	10.20	11.20
Weight [kg] (without ballast)	415.3	491.8	506.9	583.4	598.5	675.0
Ballasting (stated in units)						
Indoors						
Assembly, central	0	0	0	0	0	0
Assembly, off-centre	0	0	LO R2	LO R2	LO R2	LO R2
Assembly, off-centre with wall bracing	0	0	0	0	0	0
Outdoors						
Assembly, central	0	0	X	X	X	X
Assembly, off-centre	LO R10	LO R12	X	X	X	X
Assembly, off-centre with wall bracing	0	0	X	X	X	X

X = not permissible / not possible 0 = no ballast required For ballasting, use Layher ballast weights, Ref. No. 1249.000, of 10 kg each. The weights are fastened quickly and securely at the right place using the handwheel coupler. All heights stated without possible spindle extension! The max. spindle extension of the relevant assembly variants can be found in the corresponding section! **Do not use any liquid or granular ballast substances.**

The ballast weights must be distributed evenly to all ballasting fixing points.

Example: L2, r2 → Fasten 2 ballast weights of 10 kg each to the ladder frame on its left-hand side, and 2 ballast weights of 10 kg each on its right-hand side.
L6, R16 → Fasten 6 ballast weights of 10 kg each to the mobile beam on its left-hand side, and 16 ballast weights of 10 kg each on its right-hand side.
In the case of off-centre assembly, r and R always relate to the side facing away from the tower; l and L relate to the side facing the tower.

3.1.3 PARTS LIST

Safety Structure P2, Tower models 1402101 – 1402111

Tower model	Ref. No.	1402101	1402102	1402103	1402104	1402105	1402106	1402107	1402108	1402109	1402110	1402111
Guardrail 2.85 m	1205.285	0	6	10	10	14	12	17	16	21	20	25
Double guardrail 2.85 m	1206.285	2	0	0	0	0	0	0	0	0	0	0
Diagonal brace 3.35 m	1208.285	0	2	2	4	4	6	6	8	8	10	10
Diagonal brace 2.95 m	1208.295	0	0	2	0	2	0	2	0	2	0	2
Basic tube 2.85 m	1211.285	0	0	0	0	0	1	1	1	1	1	1
Deck 2.85 m	1241.285	1	2	2	3	3	4	4	5	5	6	6
Access deck 2.85 m	1242.285	1	1	2	2	3	3	4	4	5	5	6
Spring clip	1250.000	0	4	4	8	8	16	16	20	20	24	24
Ladder frame 150/4 – 1.00 m	1299.004	0	2	0	2	0	2	0	2	0	2	0
Ladder frame 150/8 – 2.00 m	1299.008	2	2	4	4	6	6	8	8	10	10	12
Uni assembly hook	1300.010	0	1	1	1	1	1	1	1	1	1	1
Mobile beam 3.20 m with access ledger, adjustable	1323.320	0	0	0	0	0	2	2	2	2	2	2
Access ledger 0.75 m	1344.003	0	2	1	2	1	0	0	0	0	0	0
Castor 700	1359.200	4	4	4	4	4	4	4	4	4	4	4
End toe board 1.44 m	1438.144	2	2	2	2	2	2	2	2	2	2	2
Toe board 2.85 m with claw	1439.285	2	2	2	2	2	2	2	2	2	2	2
Ballast	1249.000	For number of ballast weights, see Section 3.1.2: Tower models										

Safety Structure P2 with stabiliser, extendible and stabiliser 5 m Tower models 1402122 – 1402131 and 1402146 – 1402151

Tower model	Ref. No.	1402122	1402123	1402124	1402125	1402126	1402127	1402128	1402129	1402130	1402131	1402146	1402147	1402148	1402149	1402150	1402151
Guardrail 2.85 m	1205.285	6	10	10	14	14	18	18	22	22	26	14	18	18	22	22	26
Diagonal brace 3.35 m	1208.285	2	2	4	4	6	6	8	8	10	10	6	6	8	8	10	10
Diagonal brace 2.95 m	1208.295	0	2	0	2	0	2	0	2	0	2	0	2	0	2	0	2
Deck 2.85 m	1241.285	1	2	2	3	3	4	4	5	5	6	3	4	4	5	5	6
Access deck 2.85 m	1242.285	1	2	2	3	3	4	4	5	5	6	3	4	4	5	5	6
Telescoping stabiliser – 2.60 m	1248.260	4	4	4	4	4	4	4	4	4	4	0	0	0	0	0	0
Rotation lock for stabiliser	1248.261	4	4	4	4	4	4	4	4	4	4	4	4	4	4	4	4
Stabiliser 5 m	1248.500	0	0	0	0	0	0	0	0	0	0	4	4	4	4	4	4
Spring clip	1250.000	4	4	8	8	12	12	16	16	20	20	12	12	16	16	20	20
Ladder frame 150/4 – 1.00 m	1299.004	2	0	2	0	2	0	2	0	2	0	2	0	2	0	2	0
Ladder frame 150/8 – 2.00 m	1299.008	2	4	4	6	6	8	8	10	10	12	6	8	8	10	10	12
Uni assembly hook	1300.010	1	1	1	1	1	1	1	1	1	1	1	1	1	1	1	1
Access ledger 0.75 m	1344.003	1	1	1	1	1	1	1	1	1	1	1	1	1	1	1	1
Castor 700	1359.200	4	4	4	4	4	4	4	4	4	4	4	4	4	4	4	4
End toe board 1.44 m	1438.144	2	2	2	2	2	2	2	2	2	2	2	2	2	2	2	2
Toe board 2.85 m with claw	1439.285	2	2	2	2	2	2	2	2	2	2	2	2	2	2	2	2
Ballast	1249.000	For number of ballast weights, see Section 3.1.2: Tower models															

Extra requirements for assembly with bracket deck surfaces

Tower model	Reference No.	1 bracket deck surface	2 bracket deck surfaces
Guardrail 2.85 m	1205.285	2	2
Deck 2.85 m	1241.285	1	2
Spring clip	1250.000	4	8
Ladder frame 75/4	1297.004	2	4
Intermediate deck	1339.285	1	2
Aluminium bracket 0.75 m	1341.075	2	4
End toe board 0.75 m	1438.075	2	4



The tower models that may be widened using **bracket deck surfaces** can be found on pages 56–59 (ballasting). When using brackets, the tower may only be loaded with 1.5 kN/m² (load class 2) at one working level only. A maximum of 2 bracket deck surfaces may be assembled. When bracket deck surfaces are fitted, the spindles must not be extended. The respective working level must be equipped with complete side protection.

3.1.4 ASSEMBLY SEQUENCE SAFETY STRUCTURE P2

Observe the general directions for assembly and use on pages 5–7. The assembly examples shown are intended for use up to a maximum platform height of 12 m indoors and up to a maximum platform height of 8 m outdoors. Snap the snap-on claws of all parts into the ladder frames from above. Level the scaffolding structure after basic assembly. This is done using the threaded spindles of the wheels.



The wheels must be locked during assembly, modification or dismantling and while there is anybody on the scaffolding structure.

Hammer home the wedges in the system until the blow bounces off. Always tighten the screw couplers well (50 Nm).

At the top level, instead of two guardrails **16**, it is also possible to fit a double guardrail **17** or a tower beam **20**. In this case, please note that additional guardrails **16** for an entire level must be present for assembly and dismantling in order to ensure collective side protection as required for the employed assembly variant. These can be removed again after inserting the double guardrails **17** or the tower beam **20**.

The **item numbers** for the components relate to the component list on pages 63–67.

BASIC ASSEMBLY Tower models 1402101



1. Insert the castors **1** in the ladder frames 150/8 **14** and secure them against falling out by tightening the wing screws on the spindle nuts.
2. Connect the two ladder frames 150/8 **14** to two double guardrails **17**. Hook the deck **27** and access deck **26** into the fourth rung from the bottom of the ladder frames 150/8 **14**.

Further assembly is performed as per page 19 “Completing the working platform”

BASIC ASSEMBLY

Tower models
1402106,
1402108 and
1402110



1. Insert the castors **1** into the mobile beams **6/7** and secure them against falling out by tightening the wing screws on the spindle nuts.
2. The mobile beams **6/7** must be connected with a basic tube **8**—or optionally with a basic strut **9**—and a deck **27**.
3. Fit two ladder frames 150/4 **13** on the mobile beams and secure using spring clips **15**.

Further assembly is performed as per page 18 “Assembly of intermediate platforms”.

BASIC ASSEMBLY

Tower models
1402107, 1402109,
1402111, 1402307,
1402309 and
1402311



1. Insert the castors **1** into the mobile beams **6/7** and secure them against falling out by tightening the wing screws on the spindle nuts.
2. The mobile beams **6/7** must be connected to one another with a basic tube **8**—or optionally with a basic strut **9**—and a guardrail **16** at the access ledger of the mobile beam.
3. Fit a ladder frame 150/8 **14** on the mobile beam **6/7** and secure it using spring clips **15**. Hook in two guardrails **16** at the topmost rung and connect to a second ladder frame 150/8 **14**. Then fit the second ladder frame 150/8 **14** at the mobile beam and secure using spring clips **15**. *Any double guardrails that might be in stock can be installed as side protection for the first level. Remove the guardrails previously installed as advancing side protection again after fitting the double guardrails.*
4. Fit two diagonal braces **22**, a deck **27** and an access deck **26**. **Make sure that a diagonal brace is installed in the direction of the access hatch. Snap the second diagonal brace on the side of the deck in the same direction but with the snap-on claw snapped into the rungs from below.** The two diagonal braces can also optionally be installed in opposite directions, crosswise (not shown).
5. Before going up, fit two additional guardrails **16** as intermediate rails to the second rung above the standing surface, starting from the assembly surface (floor / ground).

Further assembly is performed as per page 18 “Assembly of intermediate platforms”.

BASIC ASSEMBLY
Tower models 1402102,
1402104, 1402122,
1402124, 1402126,
1402128, 1402130,
1402146, 1402148,
1402150, 1402302 and
1402304



1. Insert the castors **1** in the ladder frames 150/4 **13** and secure them against falling out by tightening the wing screws on the spindle nuts.
2. Fit further ladder frames 150/8 **14**. Connect the two rolling tower side parts at the top rungs and at the bottom rungs with two guardrails **16** in each case.
3. Fit two diagonal braces **21** crosswise. Then hook in a deck **27** and an access deck **26**.
4. To maintain the maximum distance from the first rung, fit an access ledger **10** on the ascent side of the rolling tower.
5. Climb up on the inside using the rungs of the ladder frame and through the access hatch provided. While sitting in the access hatch opening, protected from falling by the sides of the access deck **26**, assemble the intermediate rail of the next level: to do so, fit the guardrails **16** to the second rungs above the standing surface (see also "Assembly of intermediate platforms", item 5)

Further assembly is performed as per page 18 "Assembly of intermediate platforms".

BASIC ASSEMBLY
Tower models 1402103,
1402105, 1402123,
1402125, 1402127,
1402129, 1402131,
1402147, 1402149,
402151, 1402303 and
1402305



1. Insert the castors **1** in the ladder frames 150/8 **14** and secure them against falling out by tightening the wing screws on the spindle nuts.
2. Connect the two rolling tower side parts at the top rungs and at the bottom rungs with two guardrails **16** in each case.
3. Fit two diagonal braces **22**, a deck **27** and an access deck **26**. **Make sure that a diagonal brace is installed in the direction of the access hatch. Snap the second diagonal brace on the side of the deck in the same direction but with the snap-on claw snapped into the rungs from below.** The two diagonal braces can also optionally be installed in opposite directions, crosswise (not shown).
4. To maintain the maximum distance from the first rung, fit an access ledger **10** on the ascent side of the rolling tower.
5. Before going up, fit two additional guardrails **16** as intermediate rails to the second rung above the standing surface, starting from the assembly surface (floor / ground).

Further assembly is performed as per page 18 "Assembly of intermediate platforms".

ASSEMBLY OF INTERMEDIATE PLATFORMS

All tower models with Safety Structure P2

i Repeat the following assembly steps 1 to 5 several times depending on the assembly height.

1. Mount the first ladder frame 150/8 **14** and secure it using spring clips **15**.

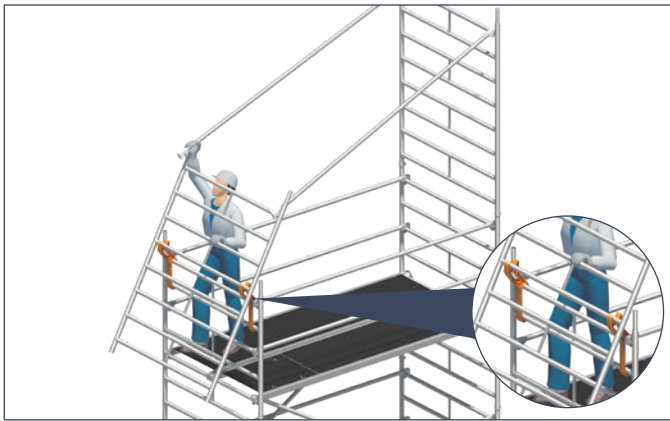

2. Attach the Uni assembly hooks **28** and position the second ladder frame 150/8 **14** in order to fit the guardrails **16**.

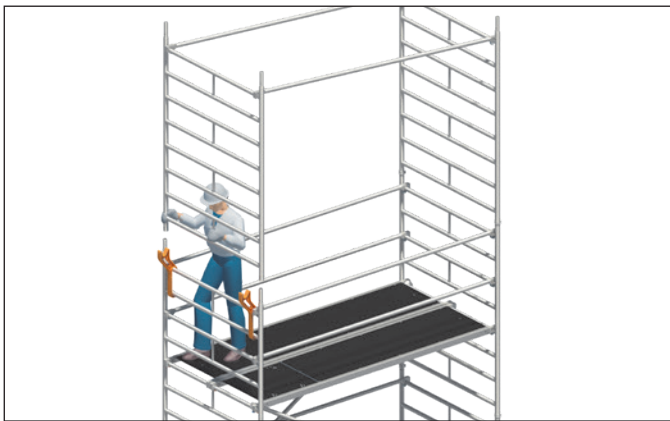

3. Swivel the ladder frame 150/8 **14** with guardrails **16** upwards, fit it in place and secure it with spring clips **15**.



4. Insert diagonal braces **21**, deck **27** and access deck **26**. Install the diagonal braces on both sides in tower-like form (so that they zig-zag).



5. Climb up on the inside using the rungs of the ladder frame and through the access hatch provided. While sitting in the access hatch opening, protected from falling by the sides of the access deck **26**, assemble the intermediate rail of the next level: to do so, fit the guardrails **16** to the second rungs above the standing surface.

COMPLETING THE WORKING PLATFORM

All tower models for creating the required working platform

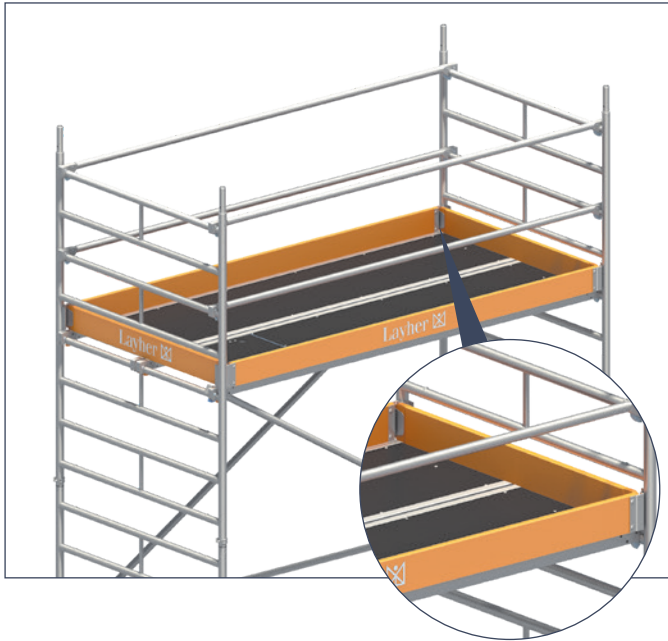

To complete the working platform, attach toe boards with claw **32** and end toe board 150 **33**.



If an intermediate platform is used as a working platform, it is also necessary to attach toe boards here.

3.1.5 DISMANTLING SEQUENCE SAFETY STRUCTURE P2

 Repeat the following dismantling steps 1 to 8 several times depending on the assembly height.

Dismantling is performed in the reverse order to assembly.

When dismantling, do not remove the bracing elements such as diagonal braces, guardrails, decks or access decks until the ladder frames above them have been dismantled.

To lift out the individual parts, open the snap-on claws by pressing their locking clips.

1. Dismantle the toe boards **32/33** (only necessary on the working platform).
2. While sitting in the access hatch opening, protected from falling by the sides of the access deck **26**, dismantle and put down the snap-on claws of both handrails on one side, the side of the access hatch, 1 metre above the standing surface.

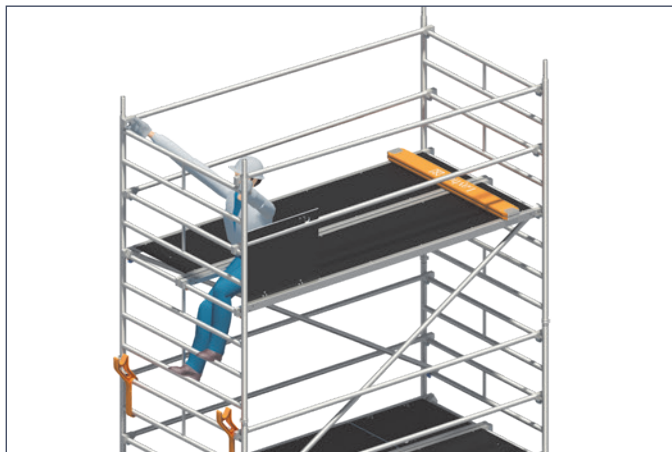

3. After climbing down to the platform underneath, dismantle the access deck **26**, the deck **27** and the diagonal braces **21**.

4. Attach the Uni assembly hooks **28** at the side of the access hatch opening above and remove the spring clips **15** on one side.



5. Lift out the ladder frame 150/8 **14** on the Uni assembly hook side and swivel it downwards with the handrails released on one side under point **2**. and with the still attached intermediate rails, in order to position this unit into the previously fitted Uni assembly hooks **28**. When swivelling it down, make sure that the guardrails **16** released on one side at the top rung of the ladder frame 150/8 **14** are able to slide outwards, allowing the complete unit to be positioned in the Uni assembly hooks **28**.

6. Moving the upper guardrails **16**, already released on one side, on the outside past the upper ends of the ladder frame 150/8 **14** positioned in the Uni assembly hooks **28** allows these to be positioned for later dismantling.



7. Using the end toe board 150 **32** or an additionally available guardrail **16** to act as an extension, release the locking clip of the snap-on claws on one of the intermediate rails or guardrails **16** about 2.5 metres up in order to lift out the snap-on claw on one side. After that, release the guardrail **16** released on one side, at the side in which it is positioned in the Uni assembly hooks **28**, and remove it by rotating it 90° about its own axis.

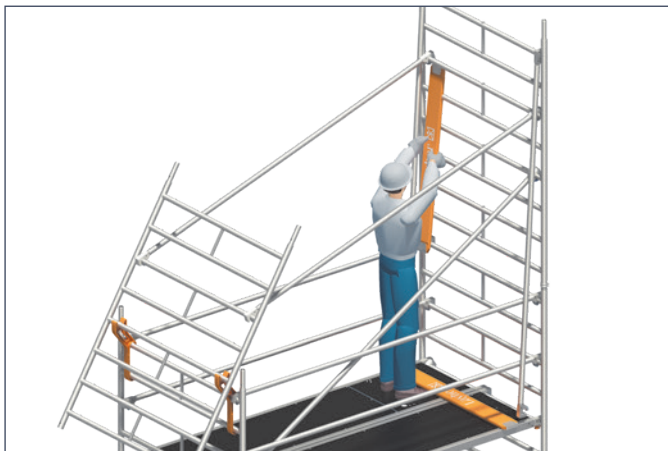

8. Lift out the remaining intermediate rail/guardrail **16** on one side at the side in which it is positioned in the Uni assembly hooks **28** and swivel the ladder frame 150/8 **14** in the Uni assembly hooks **28** into a vertical position. Next, use the guardrail **16** dismantled under point **7**. as an extension to help you dismantle the three remaining guardrails **16**. Place the loose guardrail **16** onto the rung underneath, for use as a lever to open the locking clip of the snap-on claw (see detail).

3.1.6 ASSEMBLY WITH BRACKETS

Please refer to the table on page 10 to see which tower models are allowed to be extended with brackets.

When brackets are used, the following points must also be noted:

- ▶ The tower may be loaded with 1.5 kN/m² (load class 2) at one working level only.
- ▶ To ensure stability, do not extend the spindles at all when assembling with brackets.
- ▶ In Safety Structure P2, two additional guardrails are required in order to provide the necessary two-part side protection.
- ▶ The respective working platform must be equipped with complete side protection.
- ▶ The ladder frames must be assembled in the centre position.
- ▶ Attach the corresponding ballast weights (see ballasting tables, pages 10–12) before fitting the brackets.
- ▶ A maximum of two bracket deck surfaces can be fitted to a tower. The bracket deck surfaces can be used either individually on one side, both on one side or one on each side.
- ▶ The bracket deck surfaces can be fitted at any level of the tower where a deck is provided.

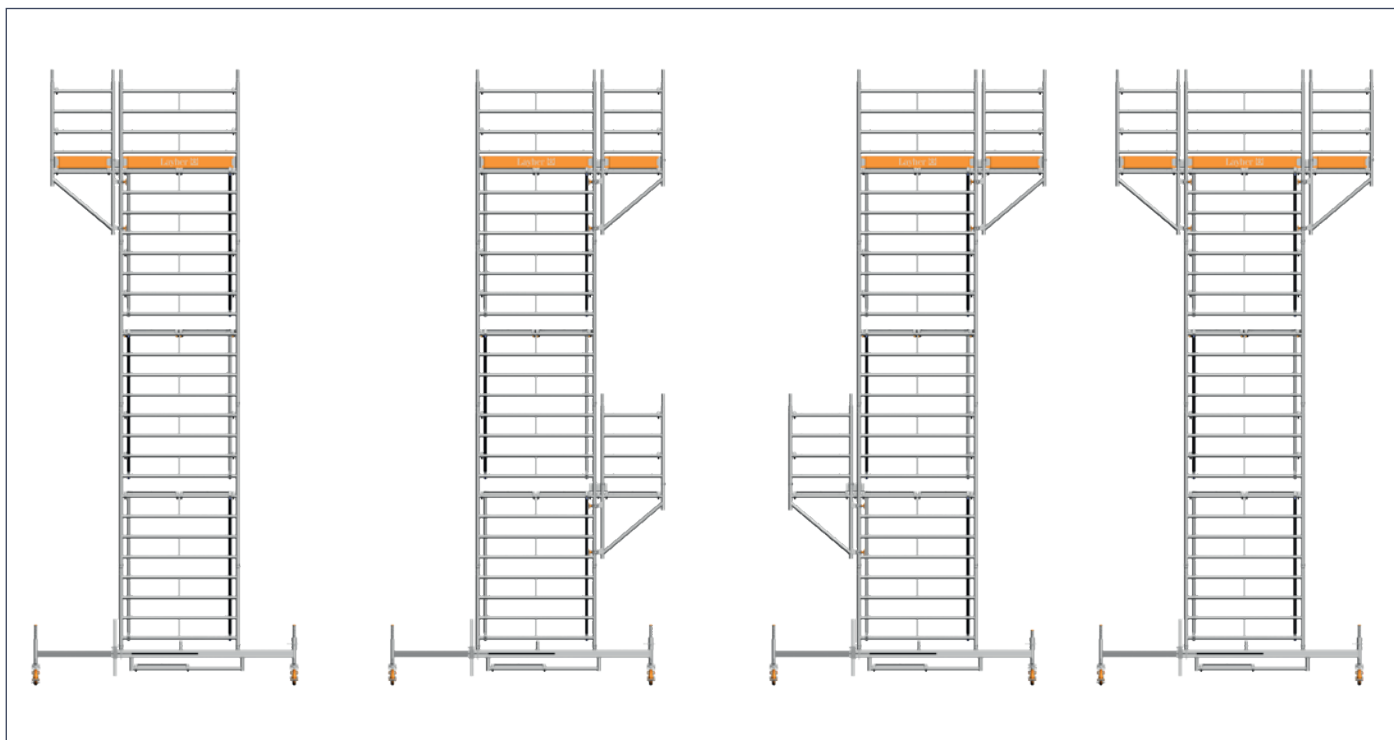

If the ballasting table is not complied with, there is an increased risk of accidents as a result of the tower tipping because of uneven loading.

Assembly

1. Assembly up to the height required is performed in accordance with the assembly sequence already described. (page 15 ff.)
2. Remove the toe boards **32/33** before attaching the brackets **29**.
3. At the corresponding level, bolt on two brackets **29** on each side using the couplers in such a way that the rungs of the brackets **29** are at the same height as the rungs of the ladder frames **13/14**.
4. Now hook decks **27** into the rungs of each of the brackets **29**.
5. Fit the intermediate deck / intermediate decks **30** between the deck **27** in the bracket **29** and the access deck **26** in the basic structure.
6. Fit one ladder frame **75/4 31** onto each bracket **29**.
7. Next assemble the side protection of the first bracket deck surface or one-sided bracket deck surface using two additional guardrails **16**. Passing over the existing side protection in the basic structure, hook the two guardrails **16** in the top rung and third rung from the top in the ladder frames **75/4 31** of the bracket deck surface. If there is a bracket deck surface on both sides, release the side protection of the basic structure, on which side protection is already provided in the bracket deck surface. Similarly, passing over the existing side protection of the basic structure, now also mount the two guardrails **16** for the second bracket deck surface in the ladder frames **75/4 31** at the top rung and third rung from the top. You can remove the two guardrails **16** that are still present in the basic structure after the two-part side protection for the bracket deck surface(s) has been completed. These can then be transported downwards or placed down in the rungs of the ladder frames **75/4 31** of the bracket deck surface(s).

8. Complete the three-part side protection depending on tower model by installing the toe boards with claw **32**. Position these on the longitudinal side on the bracket between the ladder frames **75/4 31** and secure them by inserting the end toe boards **75 34** between the toe board with claw **32** and the intermediate deck **30**. Insert the end toe board **150 33** in the basic structure between the intermediate decks.

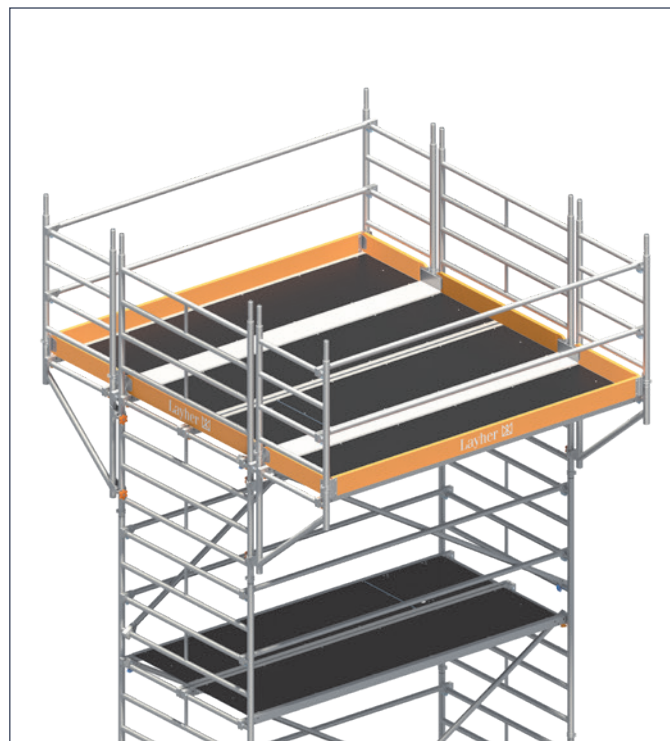

Dismantling

Dismantle the bracket deck surfaces in the reverse order to assembly. After removing the bracket deck surfaces and restoring the necessary two-part side protection in the basic structure, you can dismantle the entire tower as described in the dismantling sequence (see pages 20–21).

3.2 ROLLING TOWERS WITH SAFETY STRUCTURE P2 WITH UNI TELESCOPING GUARDRAIL

3.2.1 FALL PROTECTION MEASURES

Suitable measures for fall protection must be taken during assembly, modification or dismantling of the scaffolding structure. Safety Structure P2 with Uni telescoping guardrail implements these protective measures in full.

Safety Structure P2 with Uni telescoping guardrail

- ▶ Platforms with a vertical spacing of 2 m.
- ▶ Safer design with integrated, collective and advancing side protection.

Thanks to the platforms, which are assembled 2-m apart, both the handrails and the intermediate rails (Uni telescoping guardrails) can be fitted from the level underneath, so that when the next platform up is accessed there is already a double side protection in place on all sides.

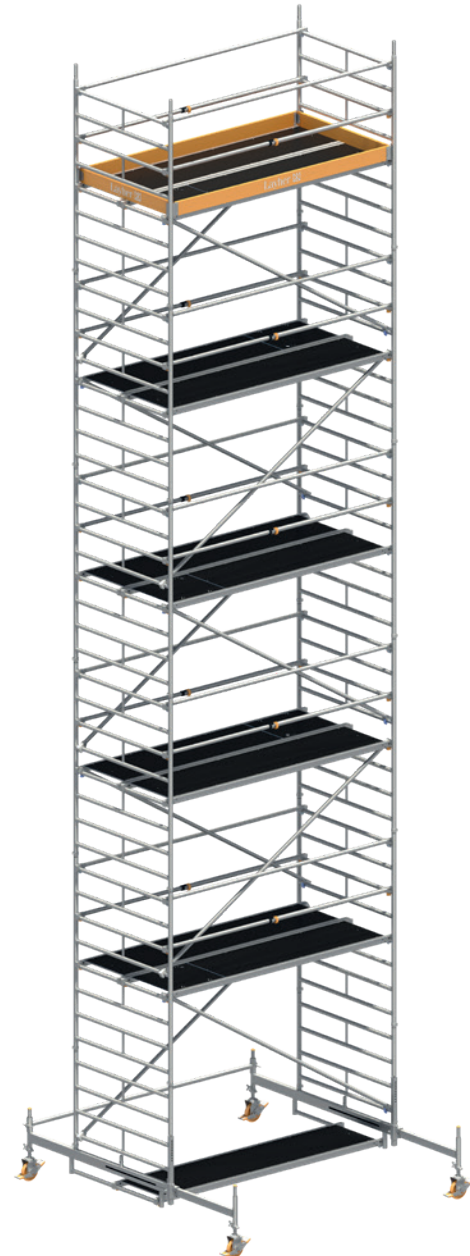
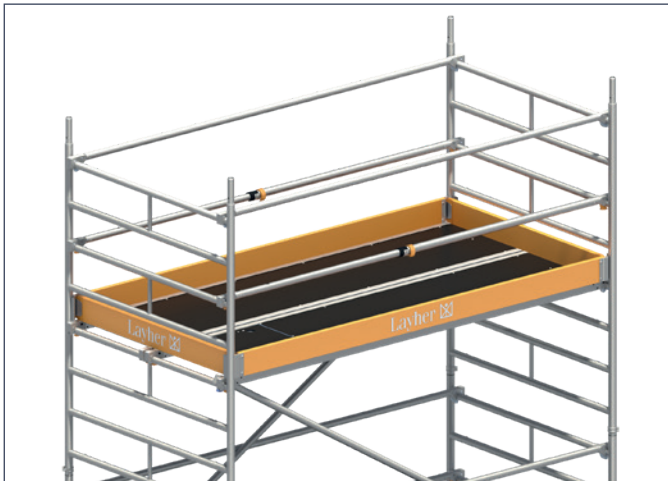



1. Attach the first ladder frame. Attach the Uni assembly hooks and position the second ladder frame in order to fit the guardrails as well as the Uni telescoping guardrails as intermediate rails.

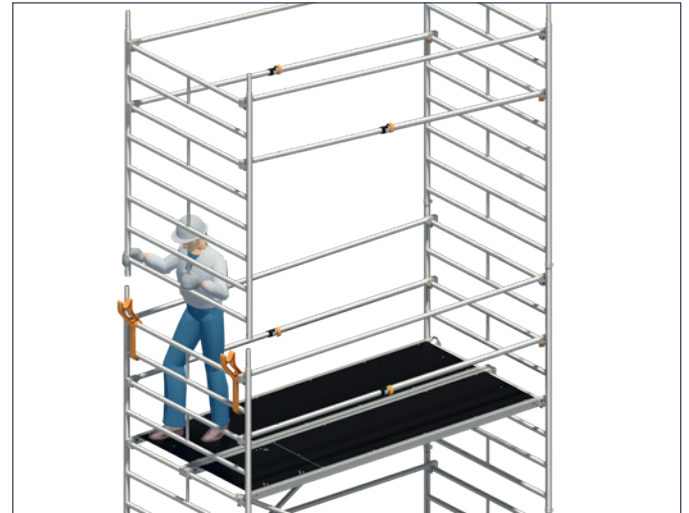

2. Swivel the ladder frame with the guardrails and Uni telescoping guardrails upwards and mount on the ladder frame underneath.

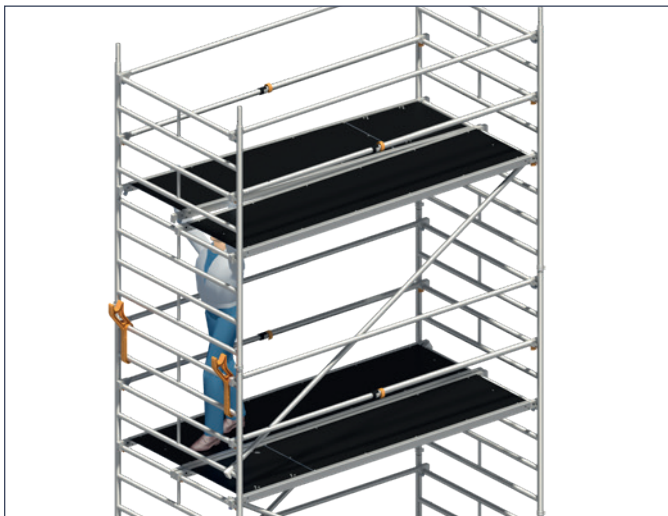

3. Insert diagonal braces, deck and access deck.

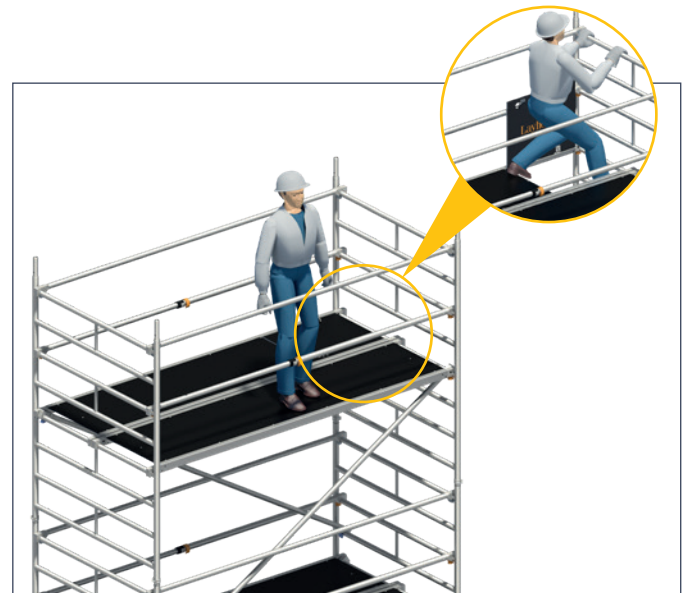

4. Access to the now secured level.

3.2.2 TOWER MODELS

1412102 – 1412111

For **assembly outdoors**, comply with the height restriction!

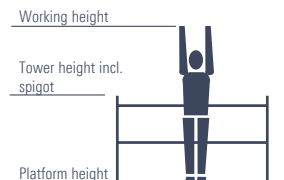

1402101: Safety Structure P2 – see Section 3.1.2



1412102



1412103



1412104



1412105



1412106



1412107



1412108



1412109



1412110



1412111

Tower model	1412102	1412103	1412104	1412105	1412106	1412107	1412108	1412109	1412110	1412111
Working height [m]	4.20	5.20	6.20	7.20	8.38	9.38	10.38	11.38	12.38	13.38
Tower height [m]	3.43	4.43	5.43	6.43	7.61	8.61	9.61	10.61	11.61	12.61
Platform height [m]	2.20	3.20	4.20	5.20	6.38	7.38	8.38	9.38	10.38	11.38
Weight [kg] (without ballast)	185.3	239.0	277.4	331.1	453.3	513.9	545.4	606.0	637.5	698.1
Ballasting (stated in units)										
Indoors										
Assembly, central*	0	0	11 r1	11 r1	0	0	0	0	0	0
Assembly, off-centre	X	X	X	X	0	0	0	0	0	0
Assembly, off-centre with wall bracing	X	X	X	X	0	0	0	0	0	0
Assembly, central with 1 bracket*	10 r10	10 r10	10 r12	10 r12	0	0	0	0	0	X
Assembly, central with 2 brackets*	13 r3	12 r2	15 r5	14 r4	0	0	X	X	X	X
Outdoors										
Assembly, central*	13 r3	16 r6	111 r11	116 r16	0	0	X	X	X	X
Assembly, off-centre	X	X	X	X	L0 R8	L0 R12	X	X	X	X
Assembly, off-centre with wall bracing	X	X	X	X	0	0	X	X	X	X
Assembly, central with 1 bracket*	10 r18	10 r22	16 r28	X	X	X	X	X	X	X
Assembly, central with 2 brackets*	114 r14	116 r16	X	X	X	X	X	X	X	X

* For assembly with adjustable mobile beam, the latter must be fully extended. X = not permissible/not possible 0 = no ballast required For ballasting, use Layher ballast weights, Ref. No. 1249.000, of 10 kg each. The weights are fastened quickly and securely at the right place using the handwheel coupler. All heights stated without possible spindle extension! The max. spindle extension of the relevant assembly variants can be found in the corresponding section! **Do not use any liquid or granular ballast substances. The ballast weights must be distributed evenly to all ballasting fixing points.**

Example: 12, r2 → Fasten 2 ballast weights of 10 kg each to the ladder frame on its left-hand side, and 2 ballast weights of 10 kg each on its right-hand side.
L6, R16 → Fasten 6 ballast weights of 10 kg each to the mobile beam on its left-hand side, and 16 ballast weights of 10 kg each on its right-hand side.
In the case of off-centre assembly, r and R always relate to the side facing away from the tower; l and L relate to the side facing the tower.

1412122 – 1412131

with Uni telescoping guardrail and stabilisers, extendible

For **assembly outdoors**, comply with the height restriction!

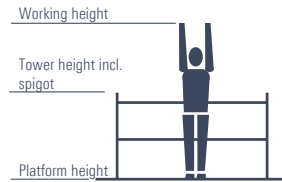

1412122

1412123

1412124



1412125

1412126

1412127

1412128

1412129

1412130

1412131

Tower model	1412122	1412123	1412124	1412125	1412126	1412127	1412128	1412129	1412130	1412131
Working height [m]	4.20	5.20	6.20	7.20	8.20	9.20	10.20	11.20	12.20	13.20
Tower height [m]	3.43	4.43	5.43	6.43	7.43	8.43	9.43	10.43	11.43	12.43
Platform height [m]	2.20	3.20	4.20	5.20	6.20	7.20	8.20	9.20	10.20	11.20
Weight [kg] (without ballast)	207.2	284.2	299.3	376.3	391.4	468.4	483.5	560.5	575.6	652.6
Ballasting (stated in units)										
Indoors										
Assembly, central	0	0	0	0	0	0	0	0	0	0
Assembly, off-centre	0	0	0	0	LO R2	LO R2	LO R2	LO R2	LO R4	LO R4
Assembly, off-centre with wall bracing	0	0	0	0	0	0	0	0	0	0
Outdoors										
Assembly, central	0	0	0	0	0	0	X	X	X	X
Assembly, off-centre	0	LO R4	LO R4	LO R10	LO R14	LO R18	X	X	X	X
Assembly, off-centre with wall bracing	0	0	0	0	0	0	X	X	X	X

X = not permissible / not possible 0 = no ballast required For ballasting, use Layher ballast weights, Ref. No. 1249.000, of 10 kg each. The weights are fastened quickly and securely at the right place using the handwheel coupler. All heights stated without possible spindle extension! The max. spindle extension of the relevant assembly variants can be found in the corresponding section! **Do not use any liquid or granular ballast substances. The ballast weights must be distributed evenly to all ballasting fixing points.**

Example: I2, r2 → Fasten 2 ballast weights of 10 kg each to the ladder frame on its left-hand side, and 2 ballast weights of 10 kg each on its right-hand side.
L6, R16 → Fasten 6 ballast weights of 10 kg each to the mobile beam on its left-hand side, and 16 ballast weights of 10 kg each on its right-hand side.
In the case of off-centre assembly, r and R always relate to the side facing away from the tower; l and L relate to the side facing the tower.

3.2.3 PARTS LIST

Safety Structure P2 with Uni telescoping guardrail, Tower models 1412102 – 1412111

Tower model	Ref. No.	1412102	1412103	1412104	1412105	1412106	1412107	1412108	1412109	1412110	1412111
Uni telescoping guardrail	1204.180	2	4	4	6	6	8	8	10	10	12
Guardrail 2.85 m	1205.285	4	6	6	8	6	9	8	11	10	13
Diagonal brace 2.85 m	1208.285	2	2	4	4	6	6	8	8	10	10
Diagonal brace 2.95 m	1208.295	0	2	0	2	0	2	0	2	0	2
Basic tube 2.85 m	1211.285	0	0	0	0	1	1	1	1	1	1
Deck 2.85 m	1241.285	2	2	3	3	4	4	5	5	6	6
Access deck 2.85 m	1242.285	1	2	2	3	3	4	4	5	5	6
Spring clip	1250.000	4	4	8	8	16	16	20	20	24	24
Ladder frame 150/4–1.00 m	1299.004	2	0	2	0	2	0	2	0	2	0
Ladder frame 150/8–2.00 m	1299.008	2	4	4	6	6	8	8	10	10	12
Uni assembly hook	1300.010	1	1	1	1	1	1	1	1	1	1
Mobile beam with access ledger, adjustable	1323.320	0	0	0	0	2	2	2	2	2	2
Access ledger	1344.003	2	1	2	1	0	0	0	0	0	0
Castor 700	1359.200	4	4	4	4	4	4	4	4	4	4
End toe board	1438.144	2	2	2	2	2	2	2	2	2	2
Toe board with claw	1439.285	2	2	2	2	2	2	2	2	2	2
Ballast	1249.000	For number of ballast weights, see Section 3.2.2: Tower models									

Safety Structure P2 with Uni telescoping guardrail and stabiliser, extendible Tower models 1411122 – 1411131

Tower model	Ref. No.	1412122	1412123	1412124	1412125	1412126	1412127	1412128	1412129	1412130	1412131
Uni telescoping guardrail	1204.180	2	4	4	6	6	8	8	10	10	12
Guardrail 2.85 m	1205.285	4	6	6	8	8	10	10	12	12	14
Diagonal brace 2.85 m	1208.285	2	2	4	4	6	6	8	8	10	10
Diagonal brace 2.95 m	1208.295	0	2	0	2	0	2	0	2	0	2
Deck 2.85 m	1241.285	1	2	2	3	3	4	4	5	5	6
Access deck 2.85 m	1242.285	1	2	2	3	3	4	4	5	5	6
Stabiliser, extendible	1248.260	4	4	4	4	4	4	4	4	4	4
Rotation lock for stabiliser	1248.261	4	4	4	4	4	4	4	4	4	4
Spring clip	1250.000	4	4	8	8	12	12	16	16	20	20
Ladder frame 150/4–1.00 m	1299.004	2	0	2	0	2	0	2	0	2	0
Ladder frame 150/8–2.00 m	1299.008	2	4	4	6	6	8	8	10	10	12
Uni assembly hook	1300.010	1	1	1	1	1	1	1	1	1	1
Access ledger	1344.003	1	1	1	1	1	1	1	1	1	1
Castor 700	1359.200	4	4	4	4	4	4	4	4	4	4
End toe board	1438.144	2	2	2	2	2	2	2	2	2	2
Toe board with claw	1439.285	2	2	2	2	2	2	2	2	2	2
Ballast	1249.000	For number of ballast weights, see Section 3.2.2: Tower models									

3.2.4 ASSEMBLY SEQUENCE SAFETY STRUCTURE P2 WITH UNI TELESCOPING GUARDRAIL

Extra requirements for assembly with bracket deck surfaces

Tower model	Reference No.	1 bracket deck surface	2 bracket deck surfaces
Guardrail 2.85 m	1205.285	2	2
Deck 2.85 m	1241.285	1	2
Spring clip	1250.000	4	8
Ladder frame 75/4	1297.004	2	4
Intermediate deck	1339.285	1	2
Aluminium bracket 0.75 m	1341.075	2	4
End toe board 0.75 m	1438.075	2	4



The tower models that may be widened using **bracket deck surfaces** can be found on page 26 (ballasting). When using brackets, the tower may only be loaded with 1.5 kN/m² (load class 2) at one working level only. A maximum of two bracket deck surfaces may be mounted. When bracket deck surfaces are fitted, the spindles must not be extended. The respective working level must be equipped with complete side protection.



The wheels must be locked during assembly, modification or dismantling and while there is anybody on the scaffolding structure.

Hammer home the wedges in the system until the blow bounces off. Always tighten the screw couplers well (50 Nm).

At the top level, instead of two guardrails **16**, it is also possible to fit a double guardrail **17** or a tower beam **20**. Please remember in this case that two additional guardrails **16** and two additional Uni telescoping guardrails **19** must be provided for assembly and dismantling in order to ensure collective two-part side protection. These can be removed again after inserting the double guardrails **17** or the tower beams **20**.

The **item numbers** for the components relate to the component list on pages 63–67.

BASIC ASSEMBLY

Tower models
1412106,
1412108 and
1412110



1. Insert the castors **1** into the mobile beams **6/7** and secure them against falling out by tightening the wing screws on the spindle nuts.
2. The mobile beams **6/7** must be connected with a basic tube **8** – or optionally with a basic strut **9** – and a deck **27**.
3. Fit two ladder frames 150/4 **13** on the mobile beams and secure using spring clips **15**.

Further assembly is performed as per page 32 “Assembly of intermediate platforms”.

BASIC ASSEMBLY

Tower models
1412107,
1412109 and
1412111



1. Insert the castors **1** into the mobile beams **6/7** and secure them against falling out by tightening the wing screws on the spindle nuts.
2. The mobile beams **6/7** must be connected to one another with a basic tube **8** – or optionally with a basic strut **9** – and a guardrail **16** at the access ledge of the mobile beam.
3. Fit a ladder frame 150/8 **14** on the mobile beam **6/7** and secure it using spring clips **15**. Hook in two guardrails **16** at the topmost rung and connect to a second ladder frame 150/8 **14**. Hook in two Uni telescoping guardrails **19**, both two rungs below the guardrails **16**, and connect these to the second ladder frame 150/8 **14** at the corresponding rung. Then swivel the second ladder frame 150/8 **14** upwards, mount it on the mobile beam and secure it with spring clips **15**. *Any double guardrails **17** that might be in stock can be installed as side protection for the first platform. In this case, assembly can be performed from the assembly surface (floor) with ladder frames 150/8 **14** mounted on both sides.*
4. Fit two diagonal braces **22**, a deck **27** and an access deck **26**. **Make sure that a diagonal brace is installed in the direction of the access hatch. Snap the second diagonal brace on the side of the deck in the same direction but with the snap-on claw snapped into the rungs from below.** The two diagonal braces can also optionally be installed in opposite directions, crosswise (not shown).

Further assembly is performed as per page 32 “Assembly of intermediate platforms”.

BASIC ASSEMBLY

Tower models

1412102, 1412104,
1412122, 1412124,
1412126, 1412128 and
1412130



1. Insert the castors **1** in the ladder frames 150/4 **13** and secure them against falling out by tightening the wing screws on the spindle nuts.
2. Mount a ladder frame 150/8 **14** on one side and secure it with spring clips **15**. To brace the structure, install the first diagonal brace **21** from the fourth rung from the bottom of ladder frame 150/8 **14** to the bottommost rung of the ladder frame 150/4 **13** opposite.
3. Hook in two guardrails **16** at the topmost rung and connect to a second ladder frame 150/8 **14**. Hook in two Uni telescoping guardrails **19**, both two rungs below the guardrails **16**, and connect these to the second ladder frame 150/8 **14** at the corresponding rung. Then swivel the second ladder frame 150/8 **14** upwards, mount it on the second ladder frame 150/4 **13** and secure it using spring clips **15**.
4. Hook in the access deck **26** and deck **27** and install the second diagonal brace **21** crosswise to the one that is already installed.
5. To maintain the maximum distance from the first rung, fit an access ledger **10** on the ascent side of the rolling tower.

Further assembly is performed as per page 32 "Assembly of intermediate platforms". Further assembly for the model 1411122 is performed as per page 33 "Completing the working platform".

BASIC ASSEMBLY

Tower models

1412103, 1412105,
1412123, 1412125,
1412127, 1412129 and
1402131



1. Insert the castors **1** in the ladder frames 150/8 **14** and secure them against falling out by tightening the wing screws on the spindle nuts.
2. Position a ladder frame 150/8 **14**, hook in two guardrails **16** at the topmost rung and connect to a second ladder frame 150/8 **14**. Hook in two Uni telescoping guardrails **19**, both two rungs below the guardrails **16**, and connect these to the second ladder frame 150/8 **14** at the corresponding rung. Then position the second ladder frame 150/8 **14** parallel to the first ladder frame and brace using the two short diagonal braces **22**. **Make sure that a diagonal brace is installed in the direction of the access hatch. Snap the second diagonal brace on the side of the deck in the same direction but with the snap-on claw snapped into the rungs from below.** The two diagonal braces can also optionally be installed in opposite directions, crosswise (not shown). *Any double guardrails **17** that might be in stock should be installed as side protection for the first platform. In this case, assembly can be performed from the assembly surface (floor) with ladder frames aligned in parallel.*
3. Fit two guardrails **16** at the bottommost rung of the ladder frames and fit a deck **27** and an access deck **26** at the fourth rung from the bottom.
4. To maintain the maximum distance from the first rung, fit an access ledger **10** on the ascent side of the rolling tower.

Further assembly is performed as per page 32 "Assembly of intermediate platforms".

ASSEMBLY OF INTERMEDIATE PLATFORMS

All tower models with Safety Structure P2 with Uni telescoping guardrail

i Repeat the following assembly steps 1 to 5 several times depending on the assembly height.

1. Mount the first ladder frame 150/8 **14** and secure using spring clips **15**.



2. Attach the Uni assembly hooks **28** and position the second ladder frame 150/8 **14**. Hook in two guardrails **16**, each at the top rung of the corresponding mounted ladder frame 150/8 **14** and connect it to a second ladder frame 150/8 **14**. Hook in two Uni telescoping guardrails **19**, both two rungs below the guardrails **16**, and connect these to the second ladder frame 150/8 **14** at the corresponding rung.

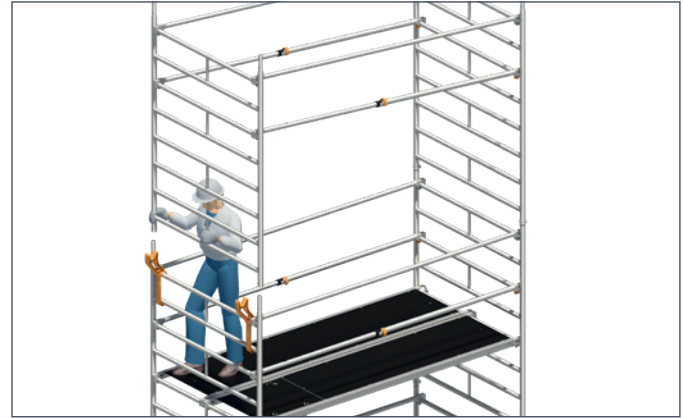

3. Swivel the second ladder frame 150/8 **14** together with the pre-assembled side protection upwards and secure using spring clips **15**.

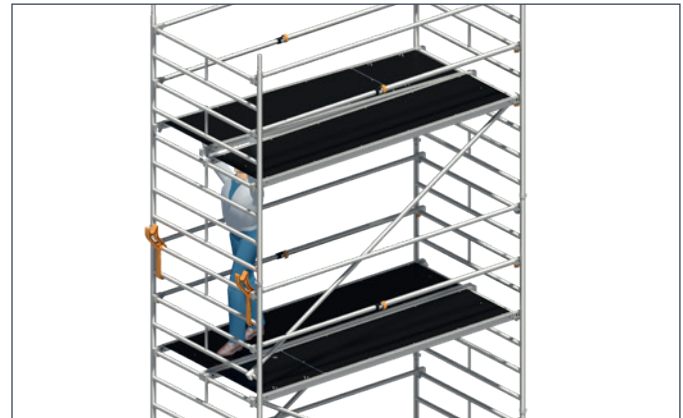

4. Insert both diagonal braces **21**, a deck **27** and the access deck **26**.

*Make sure that the diagonal braces **21** cross over one another and ascend as a tower-like structure (in a zigzag) on both sides.*

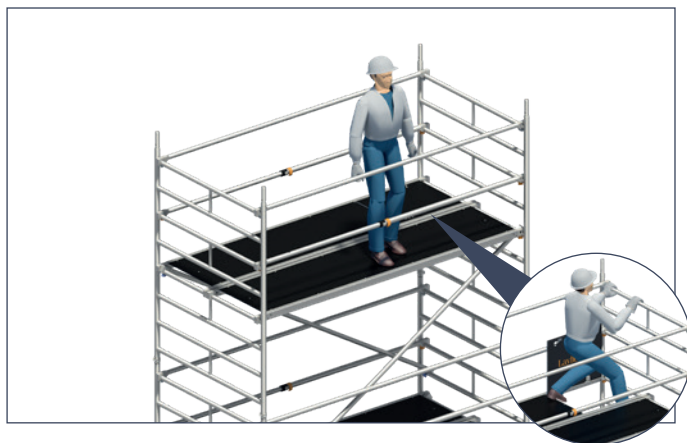

5. Move onto the next platform up, which is already completely secured by means of two-part side protection.

COMPLETING THE WORKING PLATFORM

All tower models for creating the required working platform

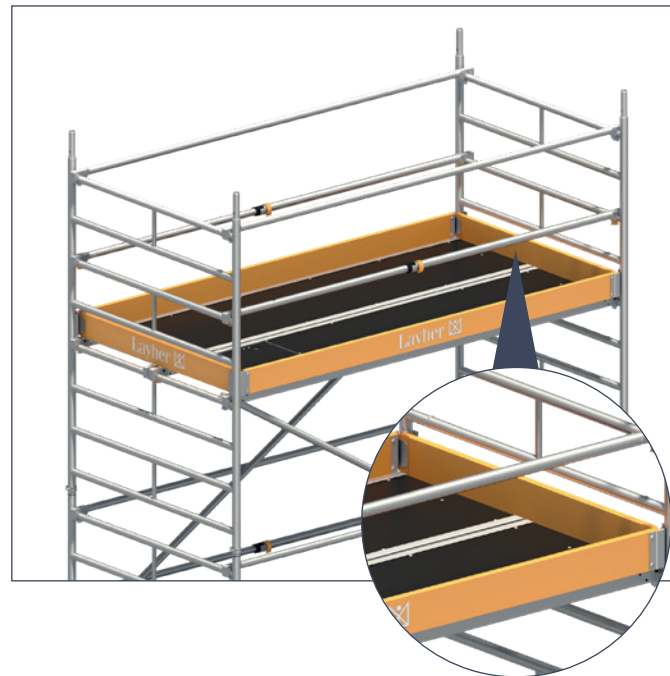

To complete the working platform, attach toe boards with claw **32** and end toe board **33**.



If an intermediate platform is used as a working platform, it is also necessary to attach toe boards here.

3.2.5 ASSEMBLY SEQUENCE SAFETY STRUCTURE P2 WITH UNI TELESCOPING GUARDRAIL

 Repeat the following dismantling steps 1 to 6 several times depending on the assembly height.

Dismantling is performed in the reverse order to assembly.

When dismantling, do not remove the bracing elements such as diagonal braces, guardrails, decks or access decks until the ladder frames above them have been dismantled.

To lift out the individual parts, open the snap-on claws by pressing their locking clips.

1. Dismantle the toe boards **32/33** (only necessary on the working platform).
2. Before coming down, make sure that the plastic spring clips of the Uni telescoping guardrails **19** are released so that the guardrail is able to telescope (see detailed images).

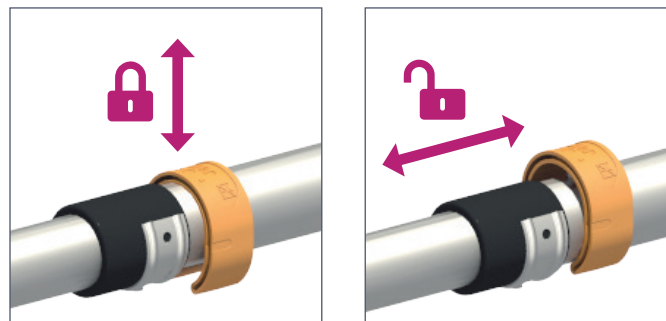

3. After climbing down to the platform underneath, dismantle the access deck **26**, the deck **27** and the diagonal braces **21**.
4. Attach the Uni assembly hooks **28** on one side and remove the spring clips **15** on the same side.

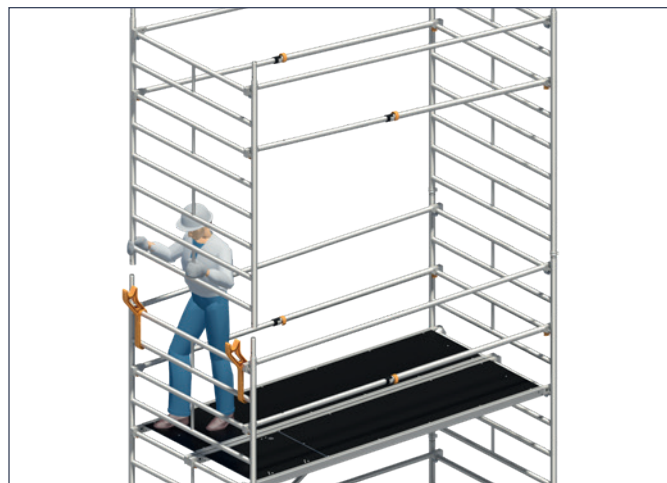

5. Lift out the ladder frame 150/8 **14** on the Uni assembly hook side, swing downwards together with the still assembled side protection and position in the Uni assembly hooks **28**.

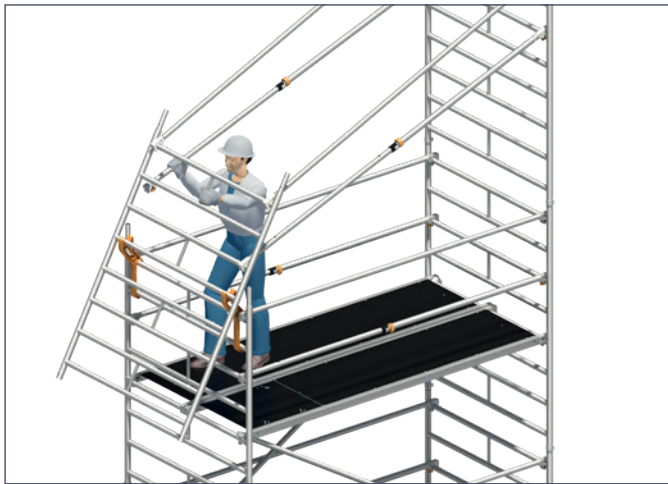

6. Dismantle the side protection. Release all the snap-on claws of the Uni telescoping guardrails **19** and the guardrails **16** from the rungs of the ladder frame 150/8 **14** on the side positioned in the Uni assembly hooks **28**. All the guardrails can be left suspended at the opposite ladder frame 150/8 **14** and remain there until the ladder frame positioned in the Uni assembly hook **28** has been secured against falling or tipping. The side protection can then be completely dismantled. Use an end toe board 150 **33** or an additionally available guardrail **16**, as an extension to release the locking clips of the snap-on claws of the Uni telescoping guardrails **19** at a height of approx. 2.5 metres in order to make it possible to lift the snap-on claws out of the rungs. Then disassemble the guardrails mounted **16** above in the same way.

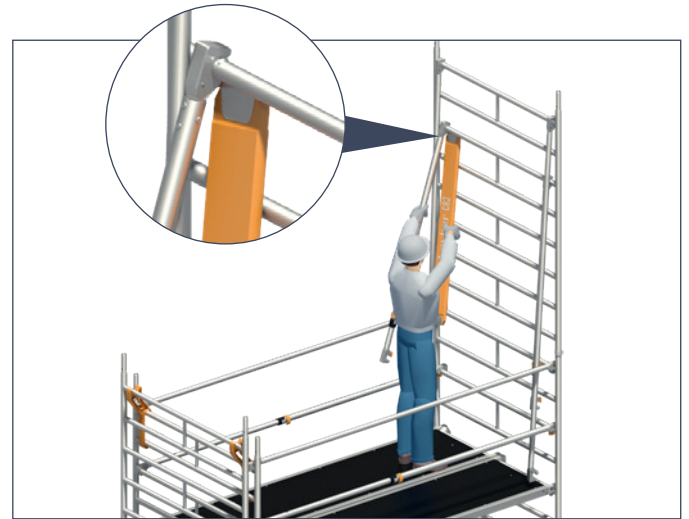

3.2.6 ASSEMBLY WITH BRACKETS

Please refer to the table on page 26 to see which tower models are allowed to be extended with brackets.

When brackets are used, the following points must also be noted:

- ▶ The tower may be loaded with 1.5 kN/m^2 (load class 2) at one working level only.
- ▶ To ensure stability, do not extend the spindles at all when assembling with brackets.
- ▶ In Safety Structure P2 with Uni telescoping guardrail, two additional guardrails are required in order to provide the necessary two-part side protection.

- ▶ The respective working platform must be equipped with complete side protection.
- ▶ The ladder frames must be assembled in the centre position.
- ▶ The corresponding ballast weights (see ballasting tables pages 26–27) must be attached before fitting the brackets.
- ▶ A maximum of two bracket deck surfaces can be fitted to a tower. The bracket deck surfaces can be used either individually on one side, both on one side or one on each side.
- ▶ The bracket deck surfaces can be fitted at any level of the tower where a deck is provided.

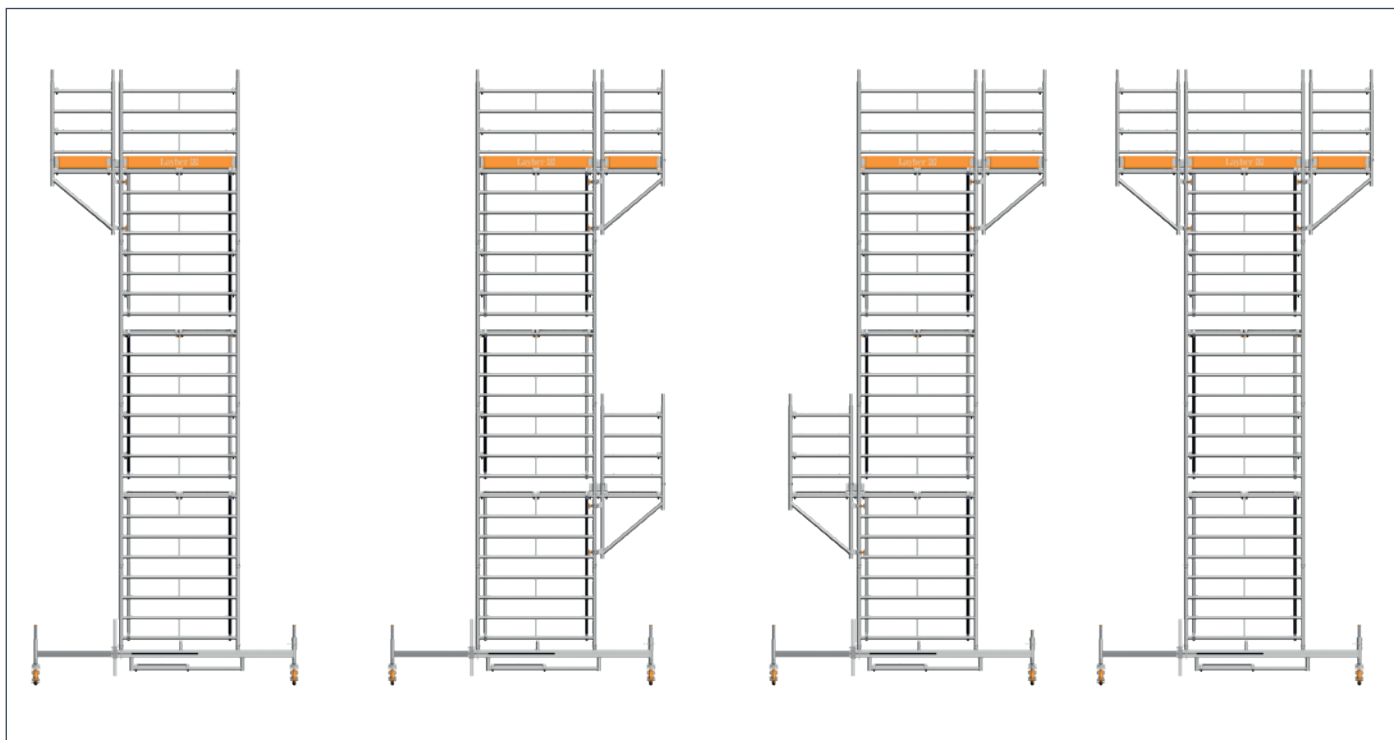

If the ballasting table is not complied with, there is an increased risk of accidents as a result of the tower tipping because of uneven loading.

Assembly

1. Assembly up to the height required is performed in accordance with the assembly sequence already described. (page 29 ff.)
2. Remove the toe boards **32/33** before attaching the brackets **29**.
3. At the corresponding level, bolt on two brackets **29** on each side using the couplers in such a way that the rungs of the brackets **29** are at the same height as the rungs of the ladder frames **13/14**.
4. Now hook decks **27** into the rungs of each of the brackets **29**.
5. Fit the intermediate deck/intermediate decks **30** between the deck **27** in the bracket **29** and the access deck **26** in the basic structure.
6. Fit one ladder frame **75/4 31** onto each bracket **29**.
7. Next assemble the side protection of the first bracket deck surface or one-sided bracket deck surface using two additional guardrails **16**. Passing over the existing side protection in the basic structure, hook the two guardrails **16** in the top rung and the third rung from the top in the ladder frames **75/4 31** of the bracket deck surface. If there is a bracket deck surface on both sides, release the side protection of the basic structure, on which side protection is already provided in the bracket deck surface. To do this, pass over the still present side protection of the basic structure and fit the guardrail **16** at the topmost rung and the Uni telescoping guardrail **19** at the third rung from the top in the ladder frames **75/4 31** of the bracket. You can remove the guardrail **16** and the Uni telescoping guardrail **19** that are still present in the basic structure after the two-part side protection for the bracket deck surface(s) has been completed. These can then be transported downwards or placed down in the rungs of the ladder frames **75/4 31** of the bracket deck surface(s).
8. To complete the three-part side protection depending on the tower model, install the toe boards with claw **32**. Position these on the longitudinal side between the ladder frames **75/4 31** on the bracket and secure them by inserting end toe boards **75 34** between the toe board with claw **32** and the intermediate deck **30**. Insert the end toe board **150 33** in the basic structure between the intermediate decks.



Dismantling

Dismantle the bracket deck surfaces in the reverse order to assembly. After removing the bracket deck surfaces and restoring the necessary two-part side protection in the basic structure, you can dismantle the entire tower as described in the dismantling sequence (see pages 34–35).

3.3 ROLLING TOWERS WITH SAFETY STRUCTURE P2 SAFETY^{PLUS} WITH DOUBLE GUARDRAIL

3.3.1 FALL PROTECTION MEASURES

Suitable measures for fall protection must be taken during assembly, modification or dismantling of the scaffolding structure. Safety Structure P2 SAFETY^{PLUS} with double guardrail implements these protective measures in full.

The Safety Structure P2 SAFETY^{PLUS} with double guardrail

- ▶ Platforms with a vertical spacing of 2 m.
- ▶ Safer design with integrated, collective and advancing side protection.

Thanks to the platforms, which are assembled 2-m apart, the necessary side protection can only be assembled and dismantled from the already secured level below. There is no other way of performing these operations, meaning that when personnel access and leave the next platform up, this already has two-part side protection on all sides.

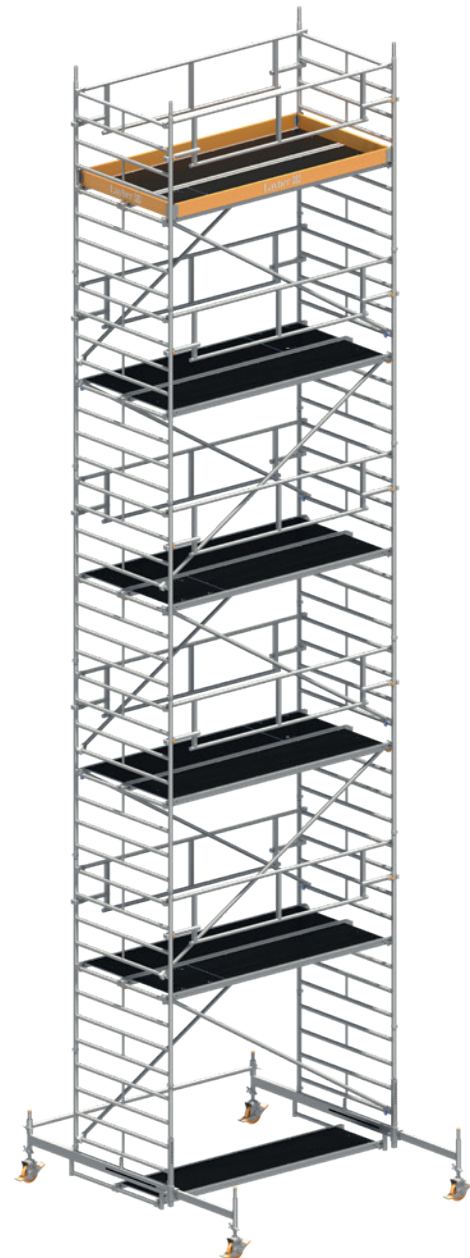
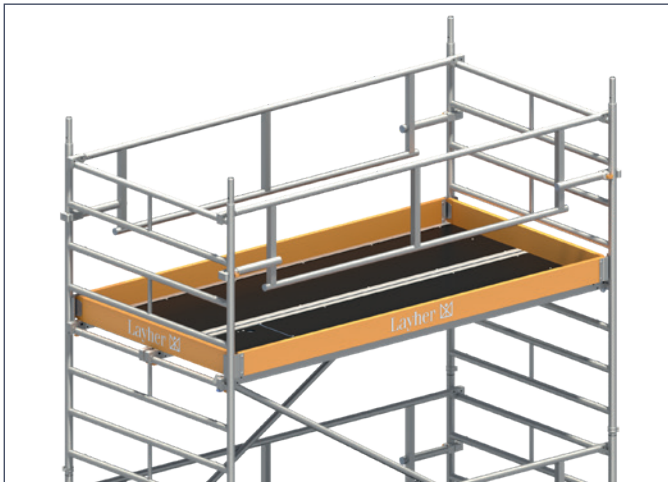



1. Attach the first ladder frame. Attach the Uni assembly hooks and position the second ladder frame in order to fit the double guardrail on both sides.

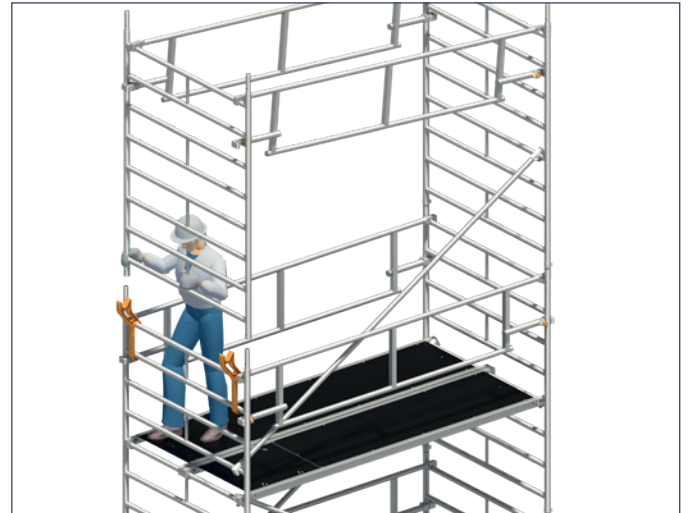

2. Swivel the ladder frame with double guardrail upwards and fit it on the ladder frame below.

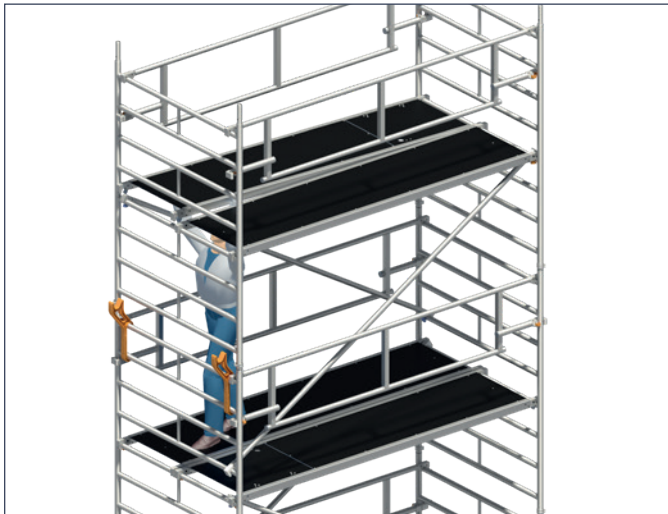

3. Insert diagonal braces, deck and access deck.



4. Move up to the already secured level and finish by snapping the dual guardrail (lower snap-on claws) into the ladder frame.

3.3.2 TOWER MODELS

1422101 – 1422111

For **assembly outdoors**, comply with the height restriction!

Working height

Tower height incl. spigot

Platform height



1422101



1422102



1422103



1422104



1422105



1422106

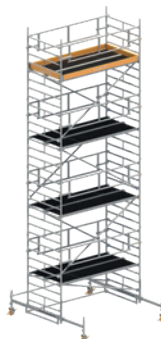

1422107

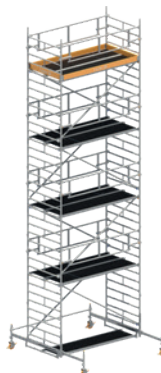

1422108



1422109

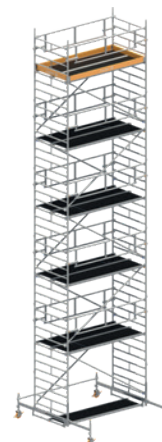

1422110

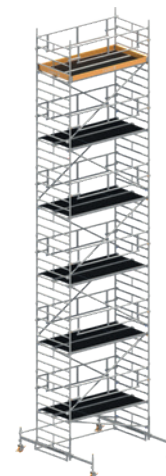

1422111

Tower model	1422101	1422102	1422103	1422104	1422105	1422106	1422107	1422108	1422109	1422110	1422111
Working height [m]	3.20	4.20	5.20	6.20	7.20	8.38	9.38	10.38	11.38	12.38	13.38
Tower height [m]	2.43	3.43	4.43	5.43	6.43	7.61	8.61	9.61	10.61	11.61	12.61
Platform height [m]	1.20	2.20	3.20	4.20	5.20	6.38	7.38	8.38	9.38	10.38	11.38
Weight [kg] (without ballast)	129.7	187.3	243.0	281.4	337.1	459.3	521.9	553.4	616.0	647.5	710.1
Ballasting (stated in units)											
Indoors											
Assembly, central*	0	0	0	l1 r1	l1 r1	0	0	0	0	0	0
Assembly, off-centre	X	X	X	X	X	0	0	0	0	0	0
Assembly, off-centre with wall bracing	X	X	X	X	X	0	0	0	0	0	0
Assembly, central with 1 bracket*	X	l0 r10	l0 r10	l0 r12	l0 r12	0	0	0	0	0	X
Assembly, central with 2 brackets*	X	l3 r3	l2 r2	l5 r5	l4 r4	0	0	X	X	X	X
Outdoors											
Assembly, central*	0	l6 r6	l11 r11	l16 r16	l23 r23	0	X	X	X	X	X
Assembly, off-centre	X	X	X	X	X	LO R12	X	X	X	X	X
Assembly, off-centre with wall bracing	X	X	X	X	X	0	X	X	X	X	X
Assembly, central with 1 bracket*	X	l0 r22	l6 r28	X	X	X	X	X	X	X	X
Assembly, central with 2 brackets*	X	l16 r16	X	X	X	X	X	X	X	X	X

* For assembly with adjustable mobile beam, the latter must be fully extended. X = not permissible/not possible 0 = no ballast required For ballasting, use Layher ballast weights, Ref. No. 1249.000, of 10 kg each. The weights are fastened quickly and securely at the right place using the handwheel coupler. All heights stated without possible spindle extension! The max. spindle extension of the relevant assembly variants can be found in the corresponding section! **Do not use any liquid or granular ballast substances. The ballast weights must be distributed evenly to all ballasting fixing points.**

Example: l2, r2 → Fasten 2 ballast weights of 10 kg each to the ladder frame on its left-hand side, and 2 ballast weights of 10 kg each on its right-hand side.
 L6, R16 → Fasten 6 ballast weights of 10 kg each to the mobile beam on its left-hand side, and 6 ballast weights of 10 kg each on its right-hand side.
 In the case of off-centre assembly, r and R always relate to the side facing away from the tower; l and L relate to the side facing the tower.

1422122 – 1422131 with double guardrail and stabilisers, extendible

For **assembly outdoors**, comply with the height restriction!

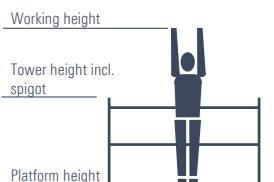

1422122

1422123

1422124

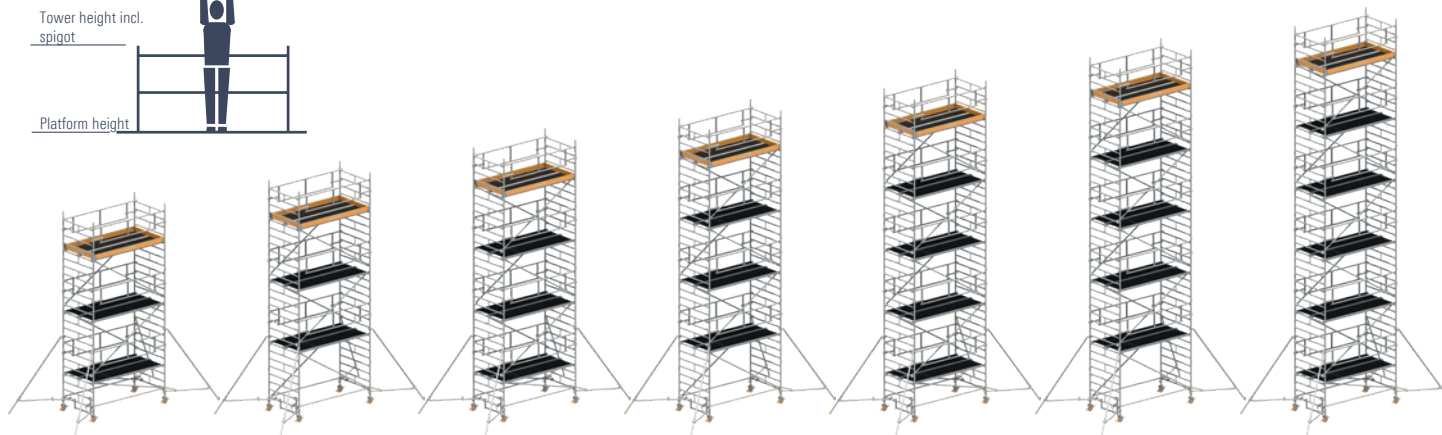

1422125

1422126

1422127

1422128

1422129

1422130

1422131

Tower model	1422122	1422123	1422124	1422125	1422126	1422127	1422128	1422129	1422130	1422131
Working height [m]	4.20	5.20	6.20	7.20	8.20	9.20	10.20	11.20	12.20	13.20
Tower height [m]	3.43	4.43	5.43	6.43	7.43	8.43	9.43	10.43	11.43	12.43
Platform height [m]	2.20	3.20	4.20	5.20	6.20	7.20	8.20	9.20	10.20	11.20
Weight [kg] (without ballast)	209.2	288.2	303.3	382.3	397.4	476.4	491.5	570.5	585.6	664.6
Ballasting (stated in units)										
Indoors										
Assembly, central	0	0	0	0	0	0	0	0	0	0
Assembly, off-centre	0	0	0	0	LO R2	LO R2	LO R2	LO R2	LO R4	LO R4
Assembly, off-centre with wall bracing	0	0	0	0	0	0	0	0	0	0
Outdoors										
Assembly, central	0	0	0	0	0	X	X	X	X	X
Assembly, off-centre	LO R4	LO R4	LO R10	LO R14	LO R18	X	X	X	X	X
Assembly, off-centre with wall bracing	0	0	0	0	0	X	X	X	X	X

X = not permissible / not possible 0 = no ballast required For ballasting, use Layher ballast weights, Ref. No. 1249.000, of 10 kg each. Fasten the weights quickly and securely at the right place using the coupler handwheel. All heights stated without possible spindle extension! The max. spindle extension of the relevant assembly variants can be found in the corresponding section! **Do not use any liquid or granular ballast substances. The ballast weights must be distributed evenly to all ballasting fixing points.**

Example: L2, r2 → Fasten 2 ballast weights of 10 kg each to the ladder frame on its left-hand side, and 2 ballast weights of 10 kg each on its right-hand side.
L6, R16 → Fasten 6 ballast weights of 10 kg each to the mobile beam on its left-hand side, and 16 ballast weights of 10 kg each on its right-hand side.
In the case of off-centre assembly, r and R always relate to the side facing away from the tower; l and L relate to the side facing the tower.

3.3.3 PARTS LIST

Safety Structure P2 SAFETY^{PLUS} with double guardrail, Tower models 1422101 – 1422111

Tower model	Ref. No.	1422101	1422102	1422103	1422104	1422105	1422106	1422107	1422108	1422109	1422110	1422111
Guardrail 2.85 m	1205.285	0	2	2	2	2	0	1	0	1	0	1
Diagonal brace 2.85 m	1208.285	0	2	2	4	4	6	6	8	8	10	10
Diagonal brace 2.95 m	1208.295	0	0	2	0	2	0	2	0	2	0	2
Basic tube 2.85 m	1211.285	0	0	0	0	0	1	1	1	1	1	1
Safety double guardrail	1216.285	2	2	4	4	6	6	8	8	10	10	12
Deck 2.85 m	1241.285	1	2	2	3	3	4	4	5	5	6	6
Access deck 2.85 m	1242.285	1	1	2	2	3	3	4	4	5	5	6
Spring clip	1250.000	0	4	4	8	8	16	16	20	20	24	24
Ladder frame 150/4–1.00 m	1299.004	0	2	0	2	0	2	0	2	0	2	0
Ladder frame 150/8–2.00 m	1299.008	2	2	4	4	6	6	8	8	10	10	12
Uni assembly hook	1300.010	0	1	1	1	1	1	1	1	1	1	1
Mobile beam with access ledger, adjustable	1323.320	0	0	0	0	0	2	2	2	2	2	2
Access ledger	1344.003	0	2	1	2	1	0	0	0	0	0	0
Castor 700	1359.200	4	4	4	4	4	4	4	4	4	4	4
End toe board	1438.144	2	2	2	2	2	2	2	2	2	2	2
Toe board with claw	1439.285	2	2	2	2	2	2	2	2	2	2	2
Ballast	1249.000	For number of ballast weights, see Section 3.3.2: Tower models										

Safety Structure P2 SAFETY^{PLUS} with double guardrail and stabiliser, extendible Tower models 1422122 – 1422131

Tower model	Ref. No.	1422122	1422123	1422124	1422125	1422126	1422127	1422128	1422129	1422130	1422131
Guardrail 2.85 m	1205.285	2	2	2	2	2	2	2	2	2	2
Diagonal brace 2.85 m	1208.285	2	2	4	4	6	6	8	8	10	10
Diagonal brace 2.95 m	1208.295	0	2	0	2	0	2	0	2	0	2
Safety double guardrail	1216.285	2	4	4	6	6	8	8	10	10	12
Deck 2.85 m	1241.285	1	2	2	3	3	4	4	5	5	6
Access deck 2.85 m	1242.285	1	2	2	3	3	4	4	5	5	6
Stabiliser, extendible	1248.260	4	4	4	4	4	4	4	4	4	4
Rotation lock for stabiliser	1248.261	4	4	4	4	4	4	4	4	4	4
Spring clip	1250.000	4	4	8	8	12	12	16	16	20	20
Ladder frame 150/4–1.00 m	1299.004	2	0	2	0	2	0	2	0	2	0
Ladder frame 150/8–2.00 m	1299.008	2	4	4	6	6	8	8	10	10	12
Uni assembly hook	1300.010	1	1	1	1	1	1	1	1	1	1
Access ledger	1344.003	1	1	1	1	1	1	1	1	1	1
Castor 700	1359.200	4	4	4	4	4	4	4	4	4	4
End toe board	1438.144	2	2	2	2	2	2	2	2	2	2
Toe board with claw	1439.285	2	2	2	2	2	2	2	2	2	2
Ballast	1249.000	For number of ballast weights, see Section 3.3.2: Tower models									

3.3.4 ASSEMBLY SEQUENCE SAFETY STRUCTURE P2 SAFETY^{PLUS} WITH DOUBLE GUARDRAIL

Extra requirements for assembly with bracket deck surfaces

Tower model	Reference No.	1 bracket deck surface	2 bracket deck surfaces
Uni telescoping guardrail	1204.180	2	2
Guardrail 2.85 m	1205.285	4	4
Deck 2.85 m	1241.285	1	2
Spring clip	1250.000	4	8
Ladder frame 75/4	1297.004	2	4
Intermediate deck	1339.285	1	2
Aluminium bracket 0.75 m	1341.075	2	4
End toe board 0.75 m	1438.075	2	4



The tower models that may be widened using **bracket deck surfaces** can be found on pages 40–41 (ballasting). When using brackets, the tower may only be loaded with 1.5 kN/m² (load class 2) at one working level only. A maximum of two bracket deck surfaces may be mounted. When bracket deck surfaces are fitted, the spindles must not be extended. The respective working level must be equipped with complete side protection.

Observe the general directions for assembly and use on pages 5–7. The assembly examples shown are intended for use up to a maximum platform height of 12 m indoors and up to a maximum platform height of 8 m outdoors. The snap-on claws of the parts should generally be fully engaged. Level the scaffolding structure after basic assembly. This is done using the threaded spindles of the wheels.



The wheels must be locked during assembly, modification or dismantling and while there is anybody on the scaffolding structure.

Hammer home the wedges in the system until the blow bounces off. Always tighten the screw couplers well (50 Nm).

The **item numbers** for the components relate to the component list on pages 63–37.

BASIC ASSEMBLY Tower models 1422101

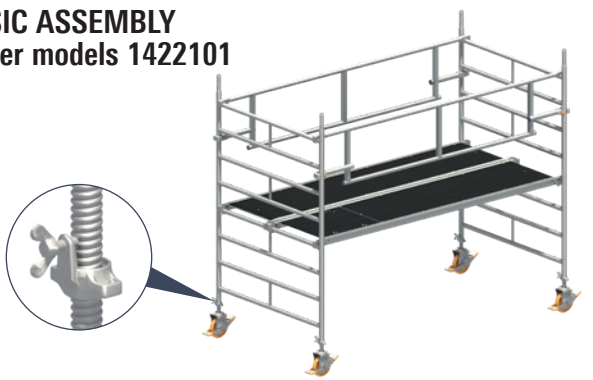

1. Insert the castors **1** in the ladder frames 150/8 **14** and secure them against falling out by tightening the wing screws on the spindle nuts.
2. Position a ladder frame 150/8 **14**, hook two safety double guardrails **18** onto the topmost rung using the snap-on housings at the top handrail and connect to a second ladder frame 150/8 **14** that has previously been positioned on the opposite side at an angle to the outside, again at the topmost rung.

In each case, make sure that the claws come up against the rung's shift preventer on the inside (bulge on the top side of the rung) in order to allow the lower claws to swivel freely.

Then swivel the second ladder frame 150/8 **14** inwards at the bottom parallel to the first ladder frame and into position so that the lower guardrail claws can be snapped on at the upright tubes.

3. Hook the deck **27** and access deck **26** into the fourth rung from the bottom of the ladder frames 150/8 **14**.

Further assembly is performed as per page 48 "Assembly of intermediate platforms".

BASIC ASSEMBLY Tower models 1422106, 1422108 and 1422110



1. Insert the castors **1** into the mobile beams **6/7** and secure them against falling out by tightening the wing screws on the spindle nuts.
2. The mobile beams **6/7** must be connected with a basic tube **8** – or optionally with a basic strut **9** – and a deck **27**.
3. Fit two ladder frames 150/4 **13** on the mobile beams and secure using spring clips **15**.

Further assembly is performed as per page 48 "Assembly of intermediate platforms".

BASIC ASSEMBLY

Tower models
1422107,
1422109 and
1422111



1. Insert the castors **1** into the mobile beams **6/7** and secure them against falling out by tightening the wing screws on the spindle nuts.
2. The mobile beams **6/7** must be connected to one another with a basic tube **8** – or optionally with a basic strut **9** – and a guardrail **16** at the access ledger of the mobile beam.
3. Fit a ladder frame 150/8 **14** on the mobile beam **6/7** and secure it using spring clips **15**. Hook two safetydouble guardrails **18** onto the topmost rung using the snap-on housings at the top handrail and connect to a second ladder frame 150/8 **14** that has previously been positioned on the opposite side at an angle to the outside, again at the topmost rung.
4. Fit two diagonal braces **22**, the deck **27** and the access deck **26**. **Make sure that a diagonal brace is installed in the direction of the access hatch. Snap the second diagonal brace on the side of the deck in the same direction but with the snap-on claw snapped into the rungs from below.** The two diagonal braces can also optionally be installed in opposite directions, crosswise (not shown).
5. Move up and onto the next platform up, which is already completely secured by means of two-part side protection. Fix the safetydouble guardrail **18** by pressing gently towards the outside in order to engage the lower claws in the upright tube of the ladder frames.

In each case, make sure that the claws come up against the rung's shift preventer on the inside (bulge on the top side of the rung) in order to allow the lower claws to swivel freely.

Then swivel the second ladder frame 150/8 **14** upwards and fit into the spigots of the mobile beam **6/7**

Further assembly is performed as per page 48 "Assembly of intermediate platforms".

BASIC ASSEMBLY

Tower models

1422102, 1422104,
1422122, 1422124,
1422126, 1422128 and
1422130



1. Insert the castors **1** in the ladder frames 150/4 **13** and secure them against falling out by tightening the wing screws on the spindle nuts.
2. Mount a ladder frame 150/8 **14** on a ladder frame 150/4 **13** and secure it using spring clips **15**. Hook two safetydouble guardrails **18** onto the topmost rung using the snap-on housings at the top handrail and connect to a second ladder frame 150/8 **14** that has previously been positioned on the opposite side at an angle to the outside, again at the topmost rung.
3. Fit two diagonal braces **21** crosswise. Assemble two guardrails **16** at the bottom rung of the ladder frame 150/4 **13** and then hook in a deck **27** and an access deck **26**.
4. To maintain the maximum distance from the first rung, fit an access ledger **10** on the ascent side of the rolling tower.
5. Move up and onto the next platform up, which is already completely secured by means of two-part side protection. Fix the safetydouble guardrail **18** by pressing gently towards the outside in order to engage the lower claws in the upright tube of the ladder frames.

In each case, make sure that the claws come up against the rung's shift preventer on the inside (bulge on the top side of the rung) in order to allow the lower claws to swivel freely.

Then swivel the second ladder frame 150/8 **14** upwards and into the spigots of the ladder frame 150/4 **13** and secure using spring clips **15**.

Further assembly is performed as per page 48 "Assembly of intermediate platforms". Further assembly for the model 1421122 is performed as per page 49 "Completing the working platform"

BASIC ASSEMBLY

Tower models

1422103, 1422105,
1422123, 1422125,
1422127, 1422129 and
1422131



1. Insert the castors **1** in the ladder frames 150/8 **14** and secure them against falling out by tightening the wing screws on the spindle nuts.
2. Position a ladder frame 150/8 **14**, hook two safety double guardrails **18** onto the topmost rung using the snap-on housings at the top handrail and connect to a second ladder frame 150/8 **14** that has previously been positioned on the opposite side at an angle to the outside, again at the topmost rung.

In each case, make sure that the claws come up against the rung's shift preventer on the inside (bulge on the top side of the rung) in order to allow the lower claws to swivel freely.

Then swivel the second ladder frame 150/8 **14** inwards at the bottom parallel to the first ladder frame and into position so that the lower guardrail claws can be snapped on at the upright tubes.

3. Hook the deck **27** and access deck **26** into the fourth rung from the bottom of the ladder frames 150/8 **14**. Fit two diagonal braces **22**. **Make sure that a diagonal brace is installed in the direction of the access hatch. Snap the second diagonal brace on the side of the deck in the same direction but with the snap-on claw snapped into the rungs from below.** The two diagonal braces can also optionally be installed in opposite directions, crosswise (not shown). Assemble two guardrails **16** at the bottom rung of the ladder frame 150/8 **14**.
4. To maintain the maximum distance from the first rung, fit an access ledger **10** on the ascent side of the rolling tower.
5. Move up and onto the next platform up, which is already completely secured by means of two-part side protection. Fix the safety double guardrail **18** by pressing gently towards the outside in order to engage the lower claws in the upright tube at the ladder frames.

Further assembly is performed as per page 48 "Assembly of intermediate platforms".

ASSEMBLY OF INTERMEDIATE PLATFORMS

All tower models with Safety Structure P2 SAFETY^{PLUS} with double guardrail

i Repeat the following assembly steps 1 to 5 several times depending on the assembly height.

1. Mount the first ladder frame 150/8 **14** and secure it using spring clips **15**.

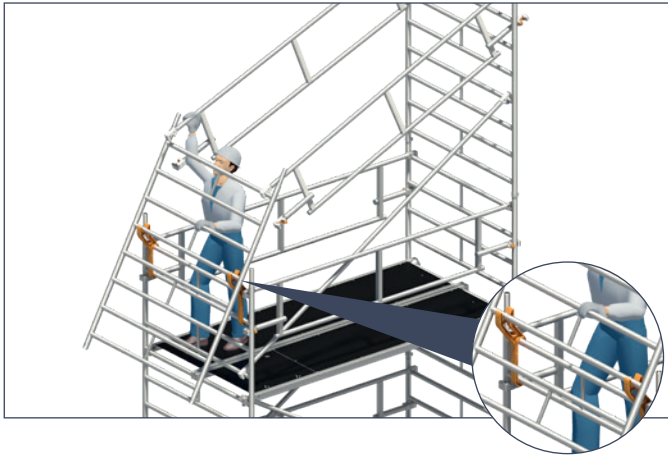

2. Attach the Uni assembly hooks **28** and position the second ladder frame 150/8 **14**. Fit a diagonal brace **21** rising from the ladder frame 150/8 **14** on the side of the Uni assembly hooks **28** to the already fitted ladder frame 150/8 **14**. Hook two safety double guardrails **18** with the snap-on housings at the top handrail in the top rung of the fitted ladder frame 150/8 **14** and connect them to the second ladder frame 150/8 **14**, which was previously positioned in the Uni assembly hook **28**, again at the top rung.

In each case, make sure that the claws come up against the rung's shift preventer on the inside (bulge on the top side of the rung) in order to allow the lower claws to swivel freely.



3. Swivel the ladder frame 150/8 **14** upwards out of its position in the Uni assembly hooks **28**, mount it and secure it using spring clips **15**.

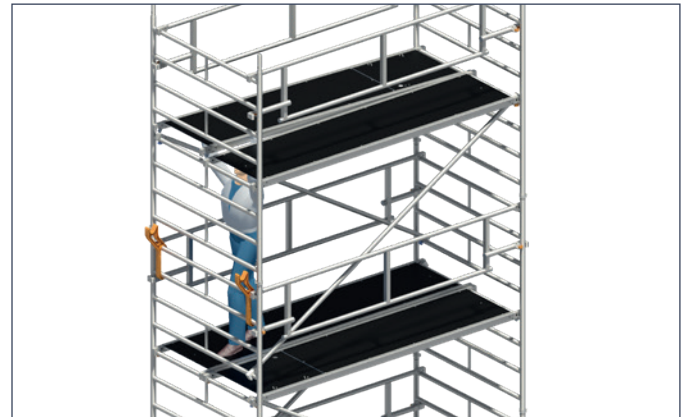

4. Insert the second diagonal brace **21**, the deck **27** and the access deck **26**.

*Make sure that the diagonal braces **21** cross over one another and ascend as a tower-like structure (in a zigzag) on both sides.*



5. Move up and onto the next platform up, which is already completely secured by means of two-part side protection. Fix the safety double guardrails **18** by pressing gently towards the outside in order to engage the lower claws in the upright tube at the ladder frames.

COMPLETING THE WORKING PLATFORM

All tower models for creating the required working platform

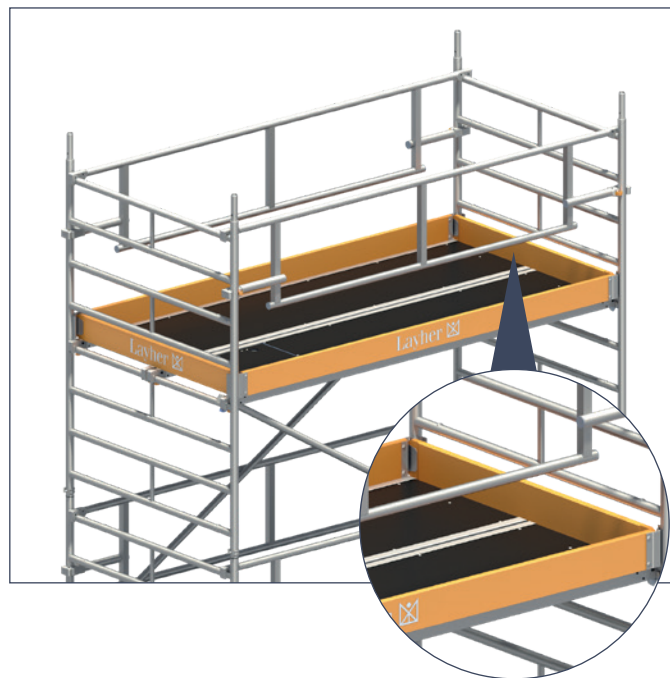

To complete the working platform, attach toe boards with claw **32** and end toe boards 150 **33**.



If an intermediate platform is used as a working platform, it is also necessary to attach toe boards here.

3.3.5 DISMANTLING SEQUENCE SAFETY STRUCTURE P2 SAFETY^{PLUS} WITH DOUBLE GUARDRAIL

 Repeat the following dismantling steps 1 to 6 several times depending on the assembly height.

Dismantling is performed in the reverse order to assembly.

When dismantling, do not remove the bracing elements such as diagonal braces, guardrails, decks or access decks until the ladder frames above them have been dismantled.

To lift out the individual parts, open the snap-on claws by pressing their locking clips.

1. Dismantle the toe boards **32/33** (only necessary on the working platform).
2. Before coming down, make sure that the fastening of the safety double guardrail **18** has been undone by releasing the lower claws at the upright tube of the ladder frame 150/8 **14**. This is easier if you lift it slightly when unlocking it. After releasing the fastening, position each of the safety double guardrails **18** with the upper claws inside at the rung's shift preventer (bulge at the top of the rung) again in order to allow the lower claws to swivel freely.



3. After climbing down to the platform below, attach the Uni assembly hooks **28** and you can remove the spring clips **15** above.
4. Dismantle the deck **27**, the access deck **26** and the diagonal brace **21** that climbs upwards in the direction of the previously mounted Uni assembly hooks **28**.



5. Lift out the ladder frame 150/8 **14** on the Uni assembly hook side and swivel it downwards together with the two safety double guardrails **18** and then position it in the Uni assembly hooks **28**.



6. Lift the two safety double guardrails **18** out of the ladder frame **150/8 14** positioned in the Uni assembly hooks **28** and place down suspended on one side at the ladder frame **150/8 14** opposite. Secure the ladder frame positioned in the Uni assembly hooks **28** against falling or tipping and then remove the safety double guardrail **18** from its suspended position. Dismantle the second diagonal brace **21** so that the ladder frame **150/8 14** that is still mounted can be removed.

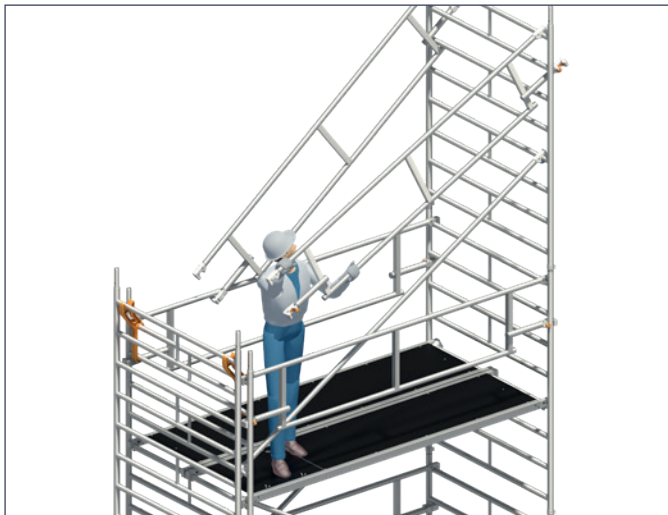

3.3.6 ASSEMBLY WITH BRACKETS

Please refer to the table on page 40 to see which tower models are allowed to be extended with brackets.

When brackets are used, the following points must also be noted:

- ▶ The tower may be loaded with 1.5 kN/m² (load class 2) at one working level only.
- ▶ To ensure stability, do not extend the spindles at all when assembling with brackets.
- ▶ To create the necessary two-part side protection with the Safety Structure P2 SAFETY^{PLUS} with double guardrail, you will **additionally** need four guardrails **16** and two Uni telescoping guardrails **19** (see point **7**. and parts list on page 43).

- ▶ The respective working platform must be equipped with complete side protection.
- ▶ The ladder frames must be assembled in the centre position.
- ▶ The corresponding ballast weights (see ballasting tables pages 40–41) must be attached before fitting the brackets.
- ▶ A maximum of two bracket deck surfaces can be fitted to a tower. The bracket deck surfaces can be used either individually on one side, both on one side or one on each side.
- ▶ The bracket deck surfaces can be fitted at any level of the tower where a deck is provided.

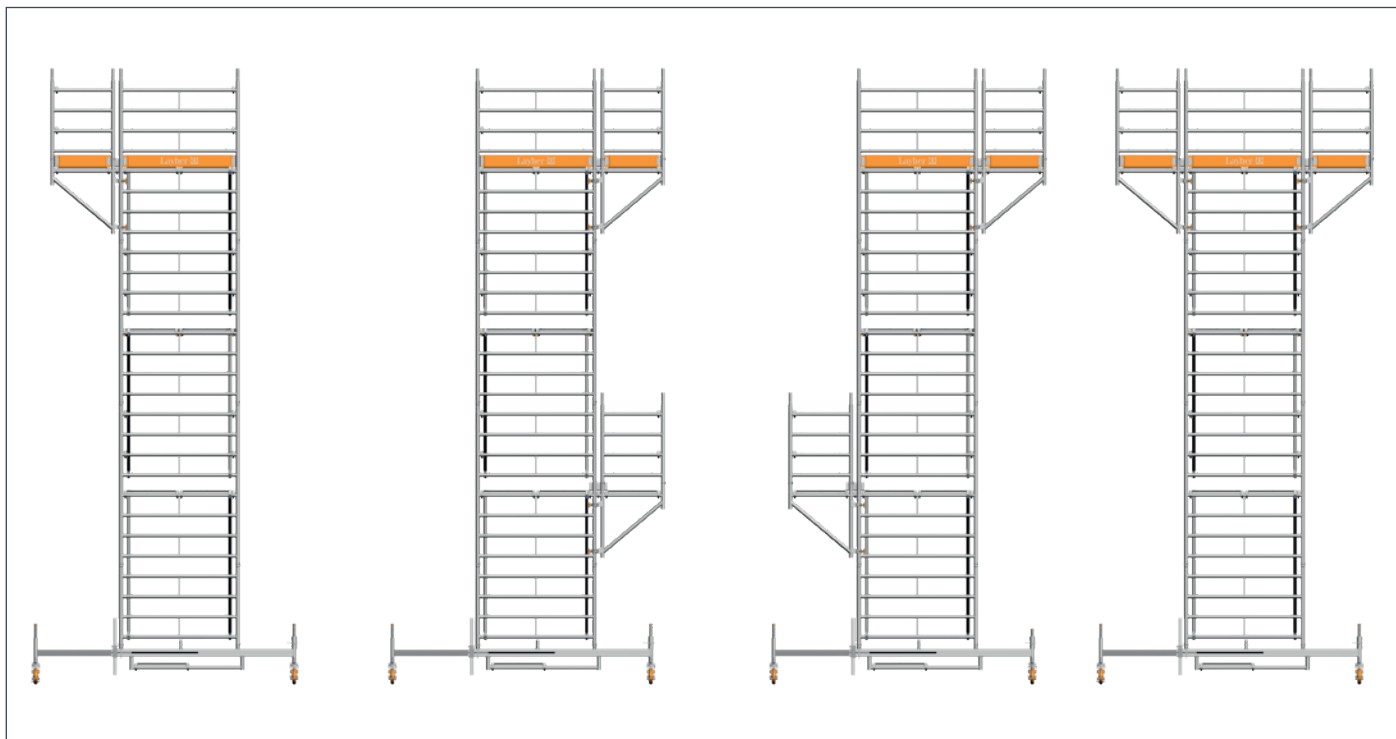

If the ballasting table is not complied with, there is an increased risk of accidents as a result of the tower tipping because of uneven loading.

Assembly



When assembly is performed with brackets, it is essential to make sure that the level in which the bracket is mounted is assembled following the assembly sequence for Safety Structure P2 with Uni telescoping guardrail 19, because the safety double guardrails 18 from the assembly sequence for Safety Structure P2 SAFETY^{PLUS} can be neither dismantled nor assembled from a higher level due to safety reasons. The assembly and dismantling sequences for Safety Structure P2 with Uni telescoping guardrail are described starting on page 32.

1. Perform assembly **up to one level below the required height** in accordance with the already described assembly sequence (page 43 ff)
2. Remove the toe boards **32/33** before attaching the brackets **29**.
3. At the corresponding level, bolt on two brackets **29** on each side using the couplers in such a way that the rungs of the brackets **29** are at the same height as the rungs of the ladder frames **13/14**.
4. Now hook decks **27** into the rungs of each of the brackets **29**.
5. Fit the intermediate deck / intermediate decks **30** between the deck **27** in the bracket **29** and the access deck **26** in the basic structure.
6. Fit one ladder frame **75/4 31** onto each bracket **29**.
7. Next assemble the side protection of the first bracket deck surface or one-sided bracket deck surface using two additional guardrails **16**. Passing over the existing side protection in the basic structure, hook the two guardrails **16** in the top rung and third rung from the top in the ladder frames **75/4 31** of the bracket deck surface. If there is a bracket deck surface on both sides, release the side protection of the basic structure, on which side protection is already provided in the bracket deck surface. To do this, pass over the still present side protection of the basic structure and fit the guardrail **16** at the topmost rung and the Uni telescoping guardrail **19** at the

third rung from the top in the ladder frames **75/4 31** of the bracket. You can remove the guardrail **16** and the Uni telescoping guardrail **19** that are still present in the basic structure after the two-part side protection for the bracket deck surface(s) has been completed. These can then be transported downwards or placed down in the rungs of the ladder frame **75/4 31** of the bracket deck surface(s).

8. To complete the three-part side protection depending on the tower model, install the toe boards with claw **32**. Position these on the longitudinal side between the ladder frames **75/4 31** on the bracket and secure them by inserting end toe boards **75 34** between the toe board with claw **32** and the intermediate deck **30**. Insert the end toe board **150 33** in the basic structure between the intermediate decks.



Dismantling

Dismantle the bracket deck surfaces in the reverse order to assembly. After removing the bracket deck surfaces and restoring the necessary two-part side protection in the basic structure, you can dismantle the entire tower as described in the dismantling sequence (see pages 50–51).

4. CASTORS AND MOBILE BEAMS

OPERATING THE CASTOR

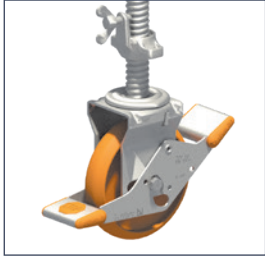

During assembly and while working, lock the castors by pressing down the brake lever labelled STOP. When the brake is locked, the lever labelled STOP must be in the down position. To move the structure, unlock the castors by pressing the opposite lever.

ADJUSTING THE MOBILE BEAM

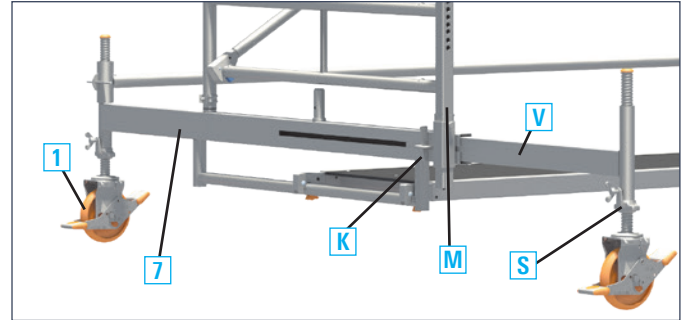

The adjustable mobile beam **6/7** makes it possible to work in a central position and at the wall without dismantling the tower. It can be pushed in and out in the assembled state. Before performing adjustment, make sure that all the ballast weights specified in the ballasting table are attached at the right place (see the corresponding "Tower models" section). For adjustment in the assembled state, lower the central support **M** attached to the mobile beam **6/7** as far as possible and secure it. Take the load off the castor **1** at the sliding parts by turning the spindles **S** far enough for the adjusting part **V** to be adjusted after releasing the clamping wedge **K**. After adjustment, fix the clamping wedge **K** in place, put the load back onto the castor **1** by extending the spindle, and then raise and secure the central support **M**.

MAXIMUM SPINDLE EXTENSION OF THE DIFFERENT TOWER MODELS

Assembly with 1323.320

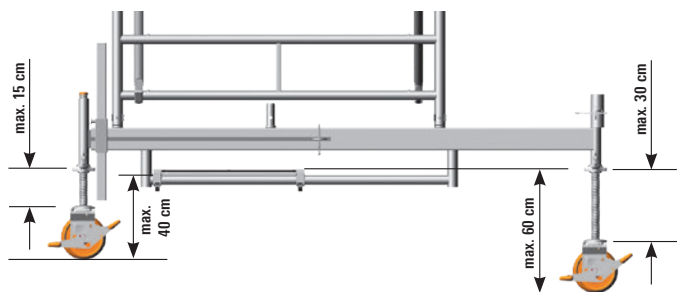

Assembly directly on wheels with access ledger

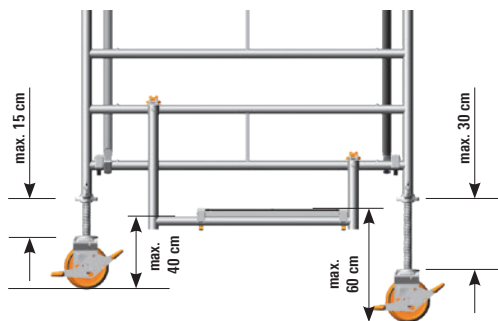

Assembly directly on castors

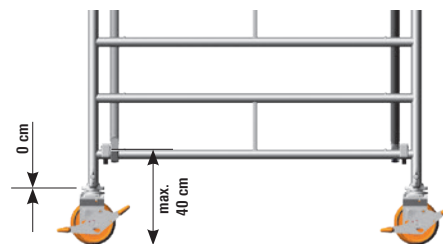

5. BALLASTING

Attachment of ballast weights

 The ballasting is independent of the assembly variant and applies to the indicated tower models. The figures are shown by way of example and refer to Safety Structure P2.

Assembly, central:

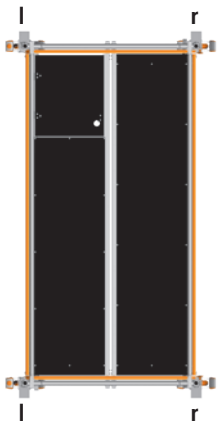

Models:
1402101 – 1402105
1412102 – 1412105
1422101 – 1422105

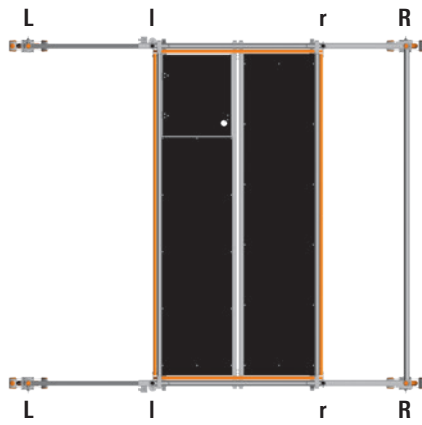

Models:
1402106 – 1402111
1412106 – 1412111
1422106 – 1422111

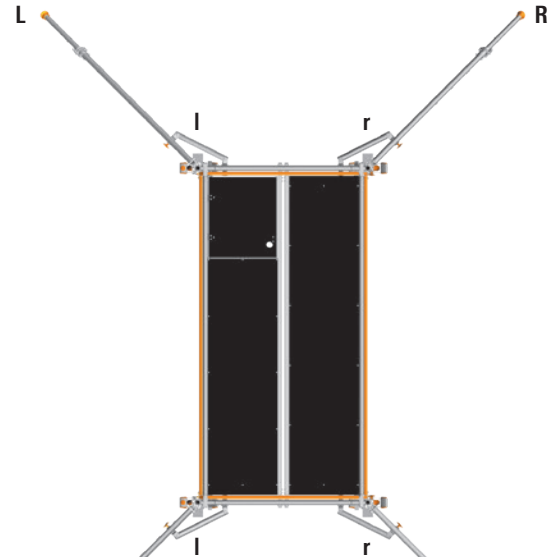

Models:
1402122 – 1402131
1402146 – 1402151
1412122 – 1412131
1422122 – 1422131





When attaching large numbers of the ballast weights required in any given case, it is possible that additional tubular components with a tube diameter of 48.3 mm may be needed as extensions at or in close proximity to the fixing points. These components (e.g. Uni distance tube, couplers, basic strut or basic tube) are not counted in the number of ballast weights in the model description or the parts lists and must be taken into account for the respective model and associated assembly site and be included as part of the assembly.

Assembly, off-centre:

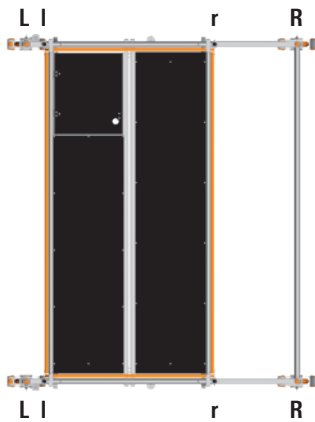

Models:
1402106 – 1402111
1412106 – 1412111
1422106 – 1422111

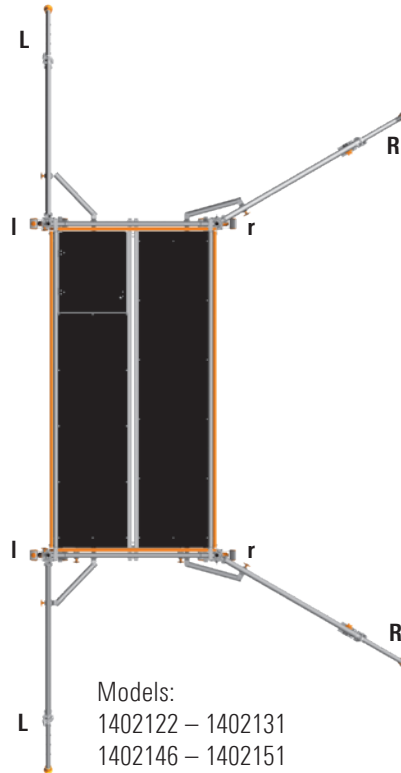

Models:
1402122 – 1402131
1402146 – 1402151
1412122 – 1412131
1422122 – 1422131

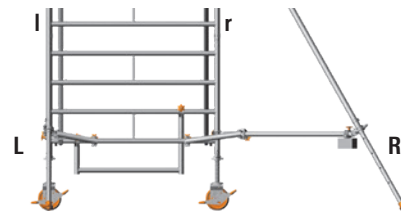

In the case of the side-mounted version with wall support, the support must always be fitted on the "L" side.

Assembly, central with brackets:

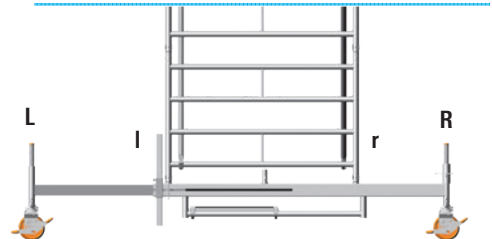
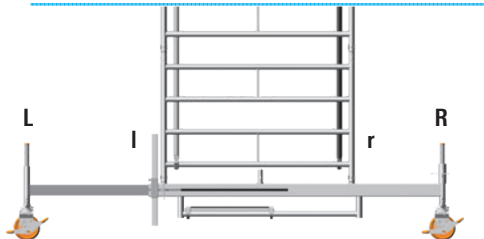
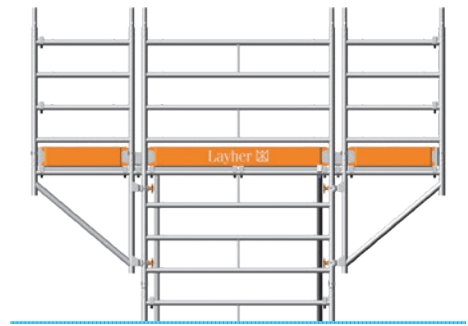
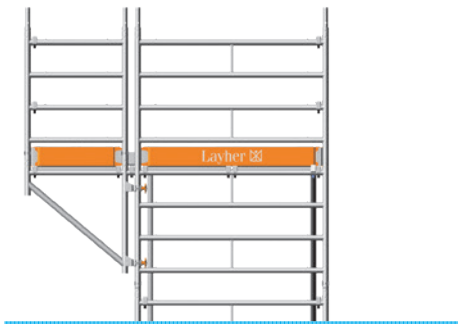
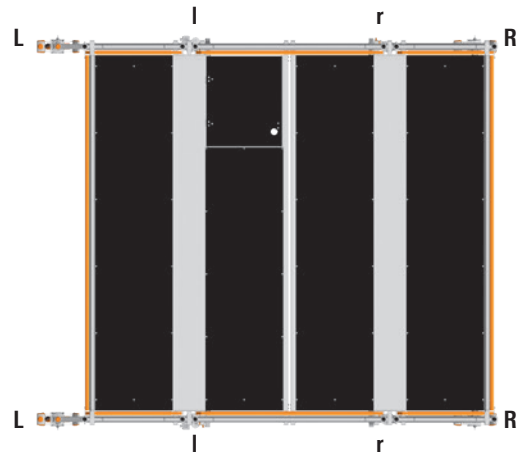
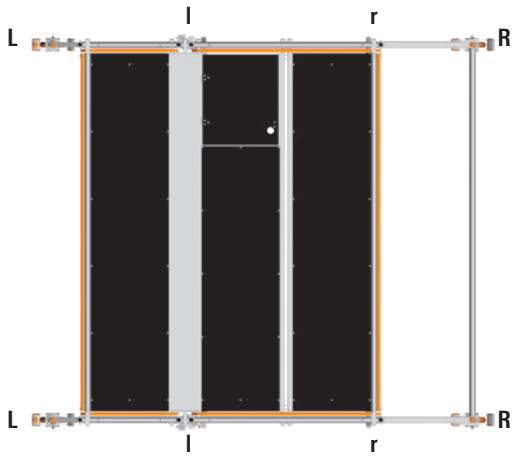

Example for assembly of model 1402104

Assembly, indoors in central position

Ballast: see corresponding "Tower models" section



Tower model	1402104
Working height [m]	6.20
Tower height [m]	5.43
Platform height [m]	4.20
Weight [kg] (without ballast)	278.7
Ballasting	
Indoors	
Assembly, central	11 r1
Assembly, off-centre	X
Assembly, off-centre with wall bracing	X
Assembly central with 1 bracket	10 r12
Assembly central with 2 brackets	15 r5
Outdoors	
Assembly, central	111 r11
Assembly, off-centre	X
Assembly, off-centre with wall bracing	X
Assembly central with 1 bracket	16 r28
Assembly central with 2 brackets	X

 The ballasting is independent of the assembly variant. The figure is shown by way of example and refers to Safety Structure P2.

6. ACCESS VIA HOOK-IN LADDER

To provide more convenient access, models 1402102–1402111/1402122–1402131/1402146–1402151, 1412102–1412111/1412122–1412131 and 1422102–1422111/1422122–1422131 can be easily equipped with the hook-in step ladder **38**.

To this end, simply snap the ladder into the eighth rung of the ladder frame **13/14** (deck level) in the access hatch area using the snap-on claws at the top end of the ladder and rest it on the deck below.

If the models are equipped with mobile beams **6/7**, ensure that at the level of the mobile beam, the hook-in step ladder **38** is equipped with the ladder stabiliser set **39** intended for it in order to maintain the tread angle of the steps.



i The use of the hook-in ladders is independent of the assembly variant and applies to the tower models indicated above. The figures are shown by way of example and refer to Safety Structure P2.

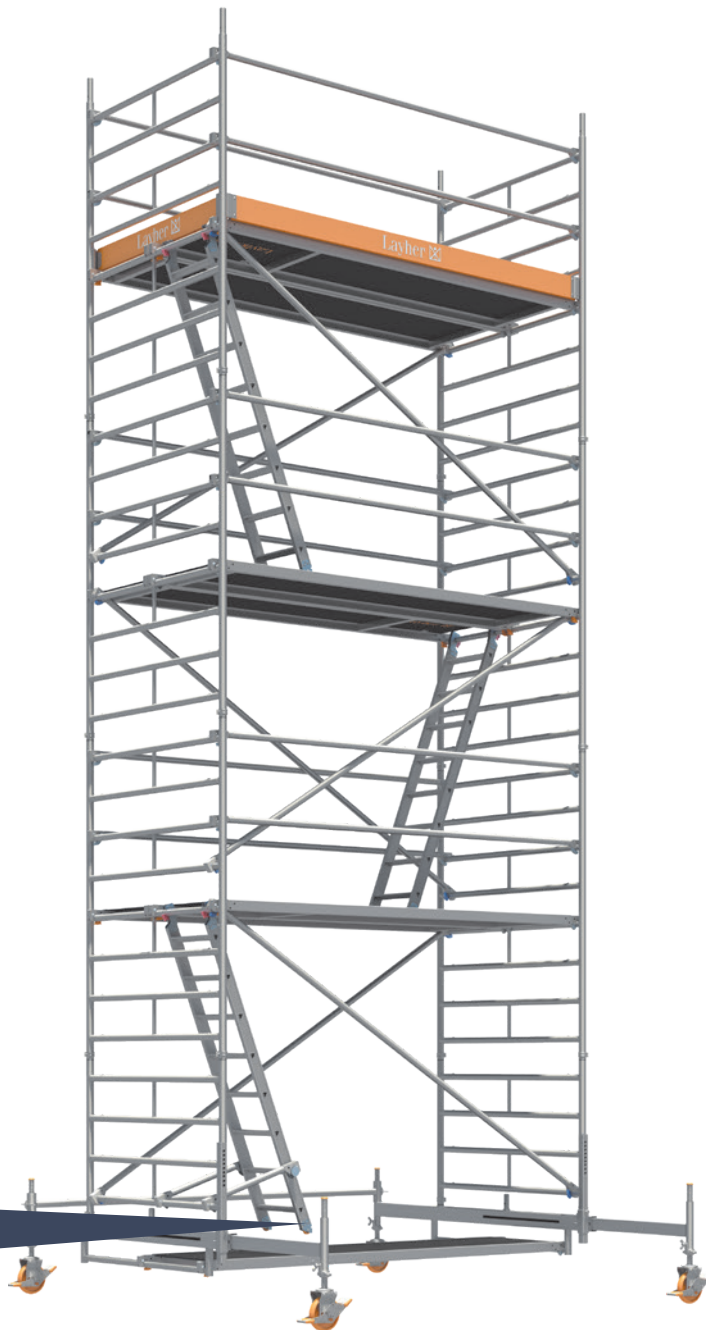

7. ATTACHING THE STABILISERS

Before attaching the stabilisers, observe the basic assembly for rolling tower models without mobile beams (see pages 17 or 31 or 46–47). Instead of mobile beams, it is also possible to use extendible stabilisers or 5-m stabilisers.



The attachment of the stabilisers is independent of the assembly variant. The figures are shown by way of example and refer to Safety Structure P2.

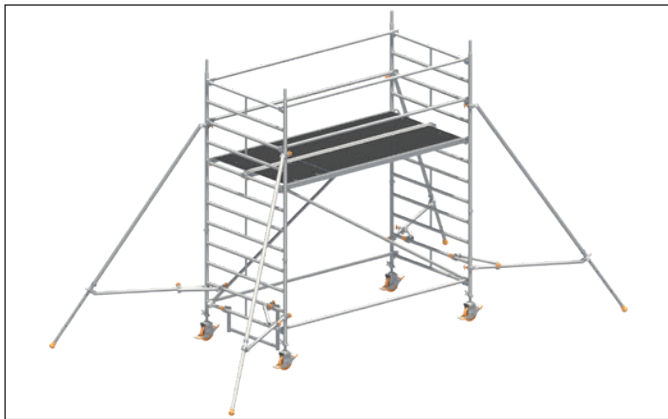

Attach a stabiliser **35/36** to each stile of the ladder frame **13/14** as follows: Position the top half-coupler of the stabiliser **35/36** at the appropriate height on the ladder frame **13/14**. Before definitively tightening the handwheels, use the half-couplers to also position the transverse tube at the appropriate height at the ladder frame **13/14**. After aligning the stabilisers in the correct position (against wall or free-standing) and ensuring a firm footing on the ground, tighten the half-couplers using the handwheels. Make sure that the spring clips safely engage in the telescoping parts of the extendible stabiliser.

Set the alignment of the stabilisers as follows:

Free-standing assembly:

in each case about 60° to the tower longitudinal side (Fig. left).

Assembly against a wall

On the wall side about 90° to the tower end face

Side facing away from the wall about 60° to the tower longitudinal side (Fig. right).

The specified angles can be checked after attachment of the stabilisers **35/36** on the basis of the length dimensions "Spacing L". To ensure that the position of the stabilisers cannot change, for example due to inadvertent rotation, attach the tower rotation lock **37** to the stabiliser **35/36**. Position the tower rotation lock **37** between the ladder frame **13/14** and the stabiliser **35/36** such that one half-coupler is fastened to the transverse tube of the stabiliser and the second half-coupler to the ladder frame rung. After positioning, tighten the half-couplers using the handwheels. When moving the Mobile Working Platform, do not lift the stabiliser **35/36** more than 2 cm off the ground. Correct ballasting of the individual models is specified in the table for ballasting (see the corresponding "Tower models" section). For work performed on a load-bearing wall, wall bracing can be fitted on both sides of the tower, allowing a reduction of the ballasting in accordance with the table (see the corresponding "Tower models" section).

Free-standing assembly

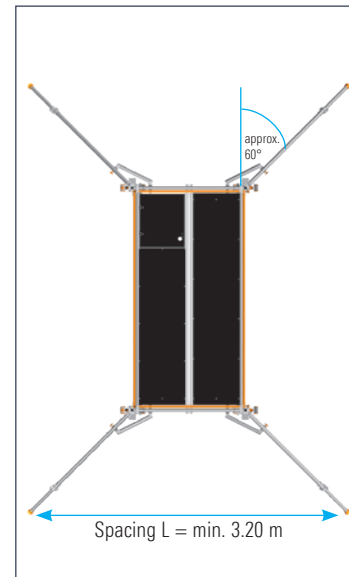

Assembly against a wall

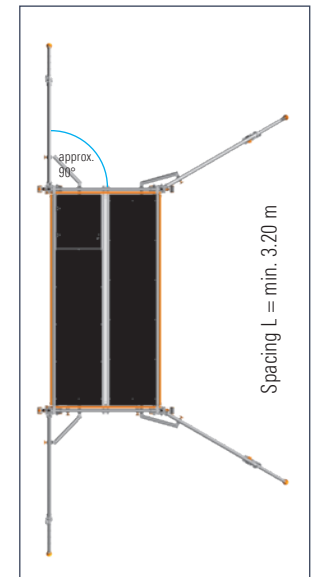

8. WALL BRACING (under compression) ANCHORING (under compression and tension)



For work performed on a load-bearing wall, you can reduce the ballasting in accordance with the **Ballasting** table (see the corresponding "Tower models" section). In this case, wall supports or anchoring must be installed on both sides of the tower. Use the Uni distance tube **24** and fix it to the ladder frame **13/14** using two couplers **25** in each case. Position the rubber mount on the wall (see detail A) to provide bracing. The Uni distance tube **24**, rotated by 180°, is used for anchoring and is fitted in an eyebolt which was attached to the wall previously (see detail B). Install the mobile beams such that they project from the side facing away from the wall. Attach the wall supports / anchoring at the height of the top working platform or at most 1 m below that.

i The wall support and anchoring are independent of the assembly variant. The figures are shown by way of example and refer to Safety Structure P2.

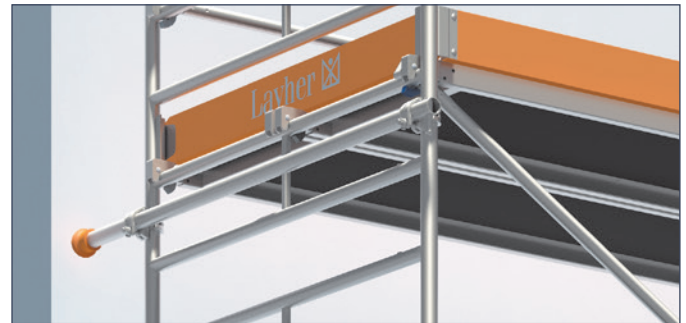

Detail A



Detail B

9. COMPONENTS OF THE SYSTEM

1



1359.200 Castor 700

Plastic wheel, D = 200 mm. With base plate, adjustment range 0.30–0.60 m, spindle nut with lock, wheel with twin brake lever and load centring when braked, permissible load: 7.0 kN (\approx 700 kg)

Functioning predecessor article 1259.200 / 1259.201 (not shown) can remain in use.

2



1358.200 Castor 700 with polyurethane tyre

Plastic wheel, D = 200 mm. With base plate, adjustment range 0.30–0.60 m, spindle nut with lock, wheel with twin brake lever and load centring when braked, permissible load: 7.0 kN (\approx 700 kg)

Functioning predecessor article 1268.200 / 1259.201 (not shown) can remain in use.

3



1260.201 Castor 1000

Plastic wheel, D = 200 mm of polyamide. With base plate, adjustment range 0.30–0.60 m, spindle nut with lock, wheel with twin brake lever and load centring when braked, permissible load: 10 kN (\approx 1,000 kg)

Functioning predecessor article 1260.200 (not shown) can remain in use.

4



1260.202 Castor 1000 with electrically conductive polyurethane tyre

Plastic wheel, D = 200 mm of polyamide with tyre of electrically conductive polyurethane. With base plate, adjustment range 0.30–0.60 m, spindle nut with lock, wheel with twin brake lever and load centring when braked. Permissible load capacity 10 kN (\approx 1,000 kg). Special wheel for sensitive floors and thanks to electrical conductivity usable in explosion-proof or in ESD-risk areas, electrical leakage resistance as per DIN EN 12526 $< 10^4 \Omega$

5



1300.150 Castor, D = 150 mm with base plate 250

Plastic wheel with base plate, adjustment range 0.2–0.35 m, spindle nut with lock, wheel with twin brake lever and load centring when braked, permissible load: 7 kN (\approx 700 kg)



6

1323.320 Mobile beam with access ledger, adjustable

Steel rectangular tube, hot-dip-galvanised, system part for base widening



7

1338.320 Mobile beam with 2 spigots, adjustable

Steel rectangular tube, hot-dip-galvanised. For base widening in special rolling tower structures. System structures only possible in combination with Ref. No. 1337.000



8

1211.285 Basic tube

Steel tube, hot-dip-galvanised



9

1324.285 Basic strut

with 2 half-couplers, steel tube hot-dip-galvanised.



10

1344.003 Access ledger

Aluminium



11

1249.000 Ballast (10 kg)

Steel, hot-dip-galvanised with half-coupler



12

1337.000 Spigot, adjustable

Steel, hot-dip-galvanised. For system structures in combination with Ref. No. 1338.320

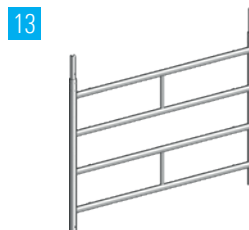

13

1299.004 Ladder frame

Aluminium, rungs with non-slip grooving.

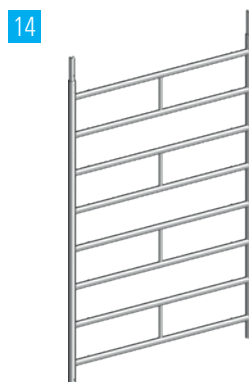

14

1299.008 Ladder frame

Aluminium, rungs with non-slip grooving.



15

1250.000 Spring clip

Steel

16



1205.285 Guardrail
Aluminium

17



1206.285 Double guardrail
Aluminium

18



1216.285 Safety double guardrail
Double guardrail 2.85 m,
aluminium

19



**1204.180 Uni telescoping
guardrail**
1.80 m + 2.85 m

20

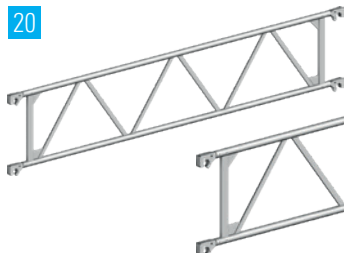

1207.285 Beam
Aluminium for use as support ele-
ment in scaffolding construction
kit or as double side protection.

21



1208.285 Diagonal brace
Aluminium

22



1208.295 Diagonal brace
Aluminium

23



1347.335 Deck diagonal brace
Aluminium

24



1275.180 Uni distance tube
Aluminium tube with hook and
rubber mount.

25



4700.019 / 4700.022
Double coupler
Steel, galvanised

26

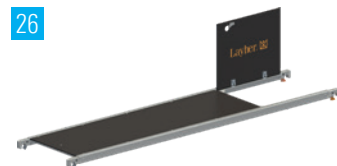

1242.285 Access deck
Aluminium frame, with plywood
deck and hatch with phenolic resin
coating

27

**1241.285 Deck**

Aluminium frame, with plywood deck with phenolic resin coating

28

**1300.010 Uni assembly hook**

Pair

29

**1341.075 Bracket**

Aluminium, for widening of the working platform on one or two sides.

30

**1339.285 Intermediate deck**

Aluminium for console bracket structures

31

**1297.004 Ladder frame**

Aluminium, rungs with non-slip grooving.

32

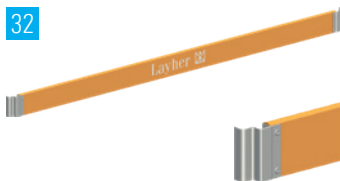
**1439.285 Toe board with claw**

Wood

33

**1438.144 End toe board**

Wood

34

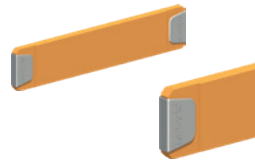
**1438.075 End toe board**

Wood

35

**1248.260 Stabiliser, extendible**

Aluminium

36

**1248.500 Stabiliser**

Aluminium

37



1248.261 Rotation lock for stabiliser

38



1314.108 Hook-in step ladder
Aluminium, 8 steps, with snap-on claw and wheels on ladder foot.

39



1314.109 Ladder stabiliser set
for hook-in ladder Ref. No. 1314.108

40



6344.400 Tower identification block
Block consisting of 50 units.

41



6344.011 See-through pocket
for Ref. No. 6344.400, 10 items with integr. prohibition sign

10. CERTIFICATE

In order to ensure up-to-date documentation, you can obtain the appropriate certificate on request using the contact details stated overleaf.



The currently available certificate applies to the assembly form **3.1 Rolling towers with Safety Structure P2**. Assembly forms **3.2 Rolling towers with Safety Structure P2 with Uni telescoping guardrail** and **3.3 Rolling towers with Safety Structure P2 SAFETY^{PLUS}** are currently undergoing certification and the corresponding certificates will be made available as soon as they have been issued.



Layher® 

More Possibilities. The Scaffolding System.

Wilhelm Layher GmbH & Co KG
Scaffolding Grandstands Ladders

Ochsenbacher Strasse 56
74363 Gueglingen-Eibensbach
Germany

P.O. Box 40
74361 Gueglingen-Eibensbach
Germany
Phone +49 (0)7135 70-0
Fax +49 (0)7135 70-265
E-mail info@layher.com
www.layher.com