

## LAYHER UNI COMPACT INSTRUCTIONS FOR ASSEMBLY AND USE

SAFETY STRUCTURE P2,  
SAFETY STRUCTURE P2 WITH UNI TELESCOPING GUARDRAIL  
AND SAFETY STRUCTURE P2 SAFETY<sup>PLUS</sup>

DIN EN 1004-2-DE



**Edition 09.2024**

Ref. No. 8107.333

Mobile Working Platforms  
According to DIN EN 1004-1:2021  
Working platform 1.50 x 1.80 m

max. working height:  
indoors 10.60 m  
outdoors 9.70 m

perm. load capacity: 2.0 kN/m<sup>2</sup>  
on max. one working level  
(Load class 3 according to  
DIN EN 1004- 1: 2021)



# CONTENTS



## ROLLING TOWERS WITH SAFETY STRUCTURE P2

- 1. Introduction ..... 4
- 2. General instructions for assembly and use ..... 5
- 3. Assembly variants
  - 3.1 Rolling Towers with Safety Structure P2 ..... 8
    - 3.1.1 Fall protection measures ..... 8
    - 3.1.2 Tower models ..... 10
    - 3.1.3 Parts list ..... 12
    - 3.1.4 Assembly sequence ..... 13
    - 3.1.5 Dismantling sequence ..... 18
- 4. Castors and mobile beams ..... 48
- 5. Ballasting ..... 50
- 6. Stabiliser attachment ..... 53
- 7. Wall bracing and anchoring ..... 54
- 8. Components of the system ..... 55
- 9. Certificate ..... 59

▶ Go directly to page 8

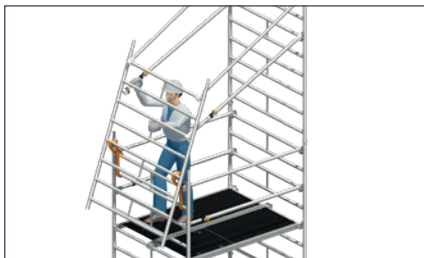

## ROLLING TOWERS WITH SAFETY STRUCTURE P2 WITH UNI TELESCOPING GUARDRAIL

- 1. Introduction ..... 4
- 2. General instructions for assembly and use ..... 5
- 3. Assembly variants
  - 3.2 Rolling towers with Safety Structure P2 with Uni telescoping guardrail ..... 22
    - 3.2.1 Fall protection measures ..... 22
    - 3.2.2 Tower models ..... 24
    - 3.2.3 Parts list ..... 26
    - 3.2.4 Assembly sequence ..... 27
    - 3.2.5 Dismantling sequence ..... 32
- 4. Castors and mobile beams ..... 48
- 5. Ballasting ..... 50
- 6. Stabiliser attachment ..... 53
- 7. Wall bracing and anchoring ..... 54
- 8. Components of the system ..... 55
- 9. Certificate ..... 59

▶ Go directly to page 22



## ROLLING TOWERS WITH SAFETY STRUCTURE P2 SAFETY PLUS WITH DOUBLE GUARDRAIL

- 1. Introduction ..... 4
- 2. General instructions for assembly and use ..... 5
- 3. Assembly variants
  - 3.3 Rolling towers with Safety Structure P2 SAFETY PLUS ..... 34
    - 3.3.1 Fall protection measures ..... 34
    - 3.3.2 Tower models ..... 35
    - 3.3.3 Parts list ..... 36
    - 3.3.4 Assembly sequence ..... 38
    - 3.3.5 Dismantling sequence ..... 46
- 4. Castors and mobile beams ..... 48
- 5. Ballasting ..... 50
- 6. Stabiliser attachment ..... 53
- 7. Wall bracing and anchoring ..... 54
- 8. Components of the system ..... 55
- 9. Certificate ..... 59

▶ Go directly to page 34



## NOTE

The DIN EN 1004-2-de-compliant products or assembly variants shown in these Instructions for Assembly and Use may be subject to country-specific regulations. Subject to local regulations, we reserve the right not to supply all of the products illustrated here.

Beyond the currently valid General Terms of Sale of Wilhelm Layher GmbH & Co KG, **no liability** is assumed for damage of whatever nature that has been incurred due to the following reasons:

- ▶ Non-compliance with instructions
- ▶ Improper assembly, and use of the product not for its intended purpose
- ▶ Use of non-original and damaged Layher components
- ▶ Unauthorised structural changes
- ▶ Improperly performed repairs, in particular when non-original Layher spare parts are used
- ▶ Events caused by force majeure (disasters, foreign objects)

The respective user shall ensure on their own responsibility that the points as stated and also the current safety regulations are complied with and that use for the intended purpose is assured.

These Instructions for Assembly and Use must:

- ▶ be available at the place of use of the Mobile Working Platform.
- ▶ be fully respected, including all the specifications they contain, during the assembly, modification and dismantling of the Mobile Working Platform. No modifications to them are permitted, or are permissible only after consultation with the manufacturer.

 These instructions cannot cover all the possible applications. If you have any questions about specific applications, please contact your local Layher partner. This contact person will be happy to provide advice and answers to all questions relating to the products, to their use or to specific assembly regulations.

## EXPLANATION OF SYMBOLS

 Additional information and notes on the assembly, modification, dismantling and use of Mobile Working Platforms and situations in which it is necessary to consult with the manufacturer are indicated by the symbol opposite.

 When assembling, modifying, dismantling or using Mobile Working Platforms, failure to observe the present Instructions for Assembly and Use and the applicable work safety regulations may result in a variety of hazards and/or require increased attention on the part of the user. Situations in which such hazards may arise and/or in which users must be required to pay increased attention are indicated by the symbol opposite.

 When assembling, modifying, dismantling or using Mobile Working Platforms, failure to observe the present Instructions for Assembly and Use and the applicable work safety regulations may result in risks due to electrical voltages. Situations in which risks due to electrical voltages may arise are indicated by the symbol opposite.

 When assembling, modifying, dismantling or using Mobile Working Platforms, failure to observe the present Instructions for Assembly and Use and the applicable work safety regulations may result in risks of falling. Situations in which risks of falling may arise are indicated by the symbol opposite.

# 1. INTRODUCTION

## General

These Instructions for Assembly and Use relate to the assembly, modification and dismantling of the **Uni Compact** Mobile Working Platform with Safety Structure P2, Safety Structure P2 with Uni Telescoping Guardrail and Safety Structure P2 SAFETY<sup>PLUS</sup> made by Wilhelm Layher GmbH & Co KG of Gueglingen-Eibensbach, Germany.



Number of persons required for assembly, modification and dismantling: ▶ 2 persons

**Caution:** Layher Uni Compact may only be assembled, modified and dismantled under the supervision of a person who has been qualified, trained and authorised for operations involving “mobile working platforms”.



## 2. GENERAL NOTES ON ASSEMBLY AND USE

The Mobile Working Platform may be used for the specified load class in accordance with the stipulations of DIN EN 1004 and taking into account the appropriate sections of the German Ordinance on Industrial Safety and Health (BetrSichV).

The user of the Mobile Working Platform must comply with the following instructions:

- ▶ The user must verify that the selected Mobile Working Platform is suitable for the work to be performed (Section 4 of BetrSichV).
- ▶ The maximum platform height for Mobile Working Platforms in accordance with DIN EN 1004 is
  - inside buildings: 12.00 m.
  - outside buildings: 8.00 m.
- ▶ Assembly, modification or dismantling of the Mobile Working Platform in accordance with the present manual may only be performed under the supervision of a qualified person or by professionally suitable employees after special instruction. Only the models shown in these manual may be built and used. The Mobile Working Platform must be inspected before, after or during assembly, but no later than before it is put into service (Section 14 of BetrSichV). During assembly, modification or dismantling, the Mobile Working Platform must be marked with a prohibition sign indicating "no entry" (BetrSichV Annex 1, Para. 3).
- ▶ It is first necessary to check that all parts, auxiliary tools and safety equipment for assembling the Mobile Working Platform are available at the site.
- ▶ All ladder frame joints must always be secured using spring clips.
- ▶ The access hatches must be kept shut whenever they are not in use.
- ▶ Mobile working platforms are not designed to be covered. Mobile working platforms are not designed to be used as side protection.
- ▶ If stipulated, the base must be widened by means, for example, of mobile beams or stabilisers or outriggers and ballast must be installed.
- ▶ Stability **must be ensured during every phase** of assembly and dismantling as well as when the platform is moved. **The necessary ballast weights and/or wall supports** (see corresponding section in these manual) **must generally be attached before any risk of falling arises.**
- ▶ The adjustable mobile beams may only be inserted in conformity with the manual. Any ballasting that is required must be installed prior to adjustment in accordance with the ballast specifications given in the section on "Scaffolding models".
- ▶ To assemble the upper platforms, the individual parts must be passed up from one level to the next. Small quantities of tools and materials can be carried up by the personnel or, failing that, hoisted to the working level using transport ropes.
- ▶ In the case of intermediate platforms used solely for ascent, toe boards can be dispensed with.
- ▶ Working on two or more working levels at the same time is not permitted. In the event of exceptions, the manufacturer must be consulted. When work is being performed on several levels, they must be completely fitted with three-part side protection.
- ▶ Horizontal and vertical loads that can cause the Mobile Working Platform to topple over should be avoided, for example:
  - due to pushing against the side protection (**max. 30 kg**).
  - Due to additional wind loads (tunnel effect of through-type buildings, unclad buildings and corners).
- ▶ Before installation, all parts must be inspected to ensure they are in flawless condition. Only undamaged original parts of the Layher Mobile Working Platforms may be used. Components such as snap-on claws and spigots must be cleaned of dirt after use. Components must be secured against slipping and impacts when transported by truck. Components must be handled in such a way that they are not damaged.
- ▶ The Mobile Working Platforms must not be subjected to any aggressive fluids or gases.
- ▶ Couplers in the structures must be tightened to 50 Nm.

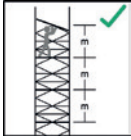

The maximum distance between the platforms must not exceed 2.25 m. Exception: The distance between the assembly level (the ground) and the first platform. The maximum distance permitted here is 3.40 m.



Mobile Working Platforms must be set to the perpendicular using the adjusting spindles or by inserting suitable materials underneath them. The max. permitted inclination is 1% (in horizontal direction = scaffolding length / 100).



Movement is only permitted on sufficiently firm ground with a max. inclination of 4% (approx. 2.5°) in the longitudinal direction or perpendicular to this, and the speed must not exceed normal walking pace (4 km/h). All impacts must be avoided.

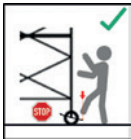

After movement, the castors must be locked by pressing down the brake lever.

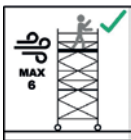

When used in the open air or in open buildings, any **work on the Mobile Working Platform must be stopped immediately if the wind strength exceeds 6 on the Beaufort scale.** At these wind speeds or at the end of a shift, Mobile Working Platforms must be moved to a location where they are protected from the wind or must be or suitable measures must be taken to secure them against toppling over.



*A wind strength of more than 6 can be recognized by noticeable difficulty in walking. If possible, Mobile Working Platforms used outside buildings must be securely fastened to the building itself or to another structure. It is recommended that Mobile Working Platforms be anchored if they are left unattended.*

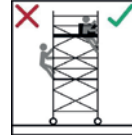

Upward access to Mobile Working Platforms is permitted only on the inside of the scaffolding structure. External access is not permitted.

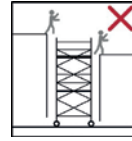

It is not permitted to climb onto and across different Mobile Working Platforms, to climb onto Mobile Working Platforms from other objects or structures or to jump onto deck surfaces.



Due to the maximum load-bearing capacity of the structure, there may be a limit to the number of persons allowed to be present on a working level at any given time. This maximum load on the working level due to persons, tools and material must be checked in advance and be limited if necessary.



*Failure to respect the maximum load limit can overload the structure and/or cause it to collapse. Serious or fatal injuries are possible.*



It is not permitted to increase the platform height by using ladders, boxes or other mechanisms.

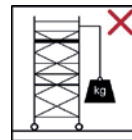

It is not permitted to lift heavy objects by attaching and using lifting gear at Mobile Working Platforms.

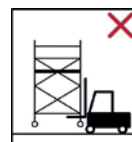

It is not permitted to lift Mobile Working Platforms using mechanical equipment.

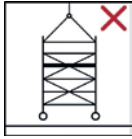

In the standard version, Mobile Working Platforms are not designed to be lifted or suspended.



*In certain cases, and following consultation with the manufacturer, it may be possible to reinforce the structure by replacing the appropriate components.*



It is not permitted to move the Mobile Working Platform when persons and/or loose objects are present on it.



It is not permissible to stand and move around on unsecured levels/platforms of Mobile Working Platforms.

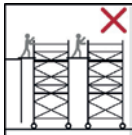

In the standard version, it is not permitted to establish bridges between different Mobile Working Platforms or between Mobile Working Platforms and other objects or structures.



*In certain cases, and following consultation with the manufacturer, it may be possible to reinforce the structure by replacing the appropriate components (special construction form) and a special verification of stability or structural calculation must then be performed for this.*

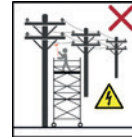

When working with Mobile Working Platforms at or in the vicinity of electrical equipment and overhead cables, it is necessary to respect the following additional instructions.

It is only permissible to assemble and use Mobile Working Platforms if:

- ▶ the equipment is no longer live.
- ▶ the deactivated equipment has been secured against reactivation.
- ▶ the equipment has been checked to ensure that no voltage is present.
- ▶ neighbouring live parts have been secured by means of protective mechanisms.
- ▶ in the case of work performed in the vicinity of overhead electrical cables, an adequate safety distance as specified in VDE 0105-100 can be / is respected.



## 3.1 ROLLING TOWERS WITH SAFETY STRUCTURE P2

### 3.1.1 FALL PROTECTION MEASURES

Suitable measures for fall protection must be taken during assembly, modification or dismantling of the scaffolding structure. Safety Structure P2 implements these protective measures in full.

#### Safety Structure P2

- ▶ Platforms with a vertical spacing of 2 m.
- ▶ Safer design with integrated, collective side protection.

Thanks to the platforms, which are assembled 2 m apart, the handrails can already be fitted from the level underneath and intermediate rails can be fitted from the secured area of the access hatch, so that when the next platform up is accessed there is already a two-part side protection in place on all sides.

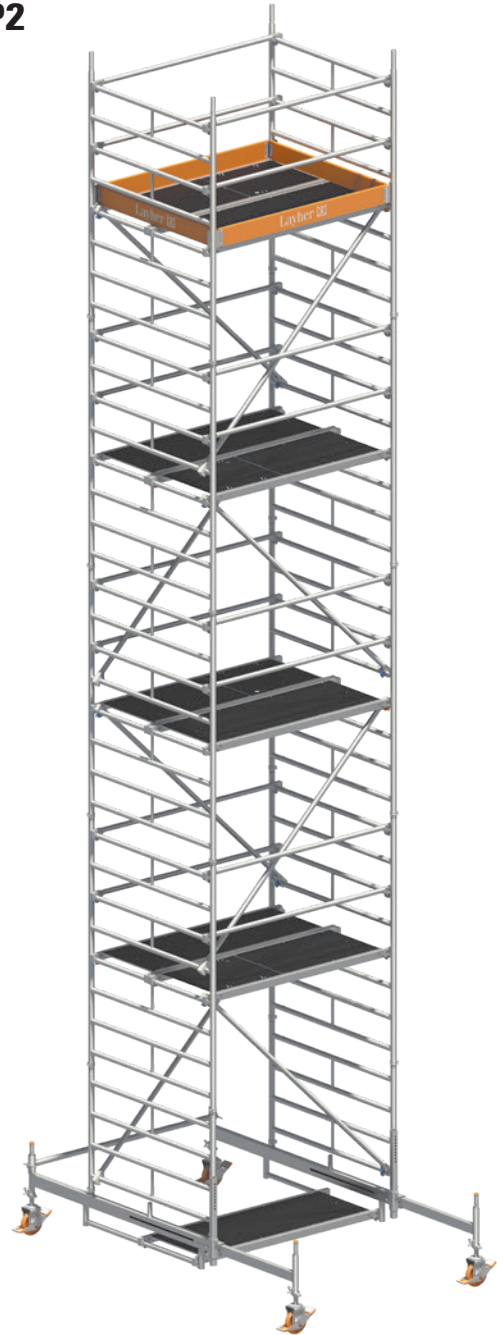



- 1.** Attach the first ladder frame.  
Attach the Uni assembly hooks and position the second ladder frame in order to fit the guardrails.

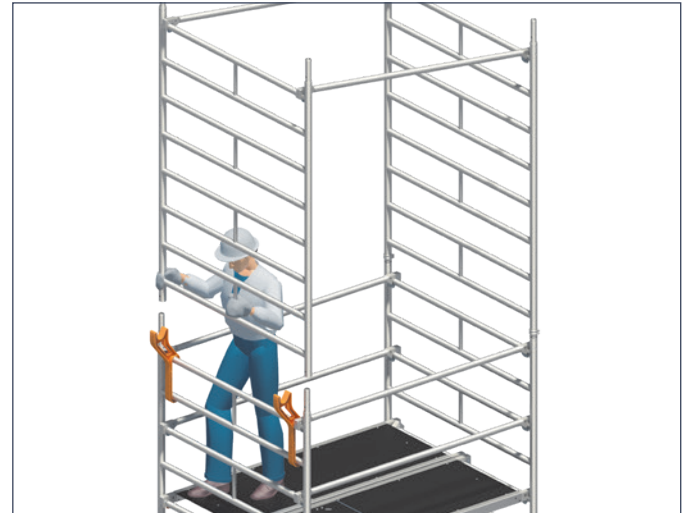

- 2.** Swivel the ladder frame with guardrail upwards and fit it in place.



- 3.** Insert diagonal braces, deck and access deck.



- 4.** Assemble the intermediate rails from a secured position in the area of the access hatch.

## 3.1.2 TOWER MODELS

### 1405001–1405008

For assembly outdoors, comply with the height restriction!

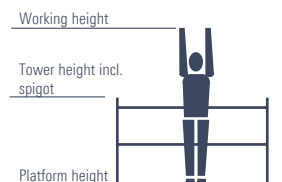

1405001



1405002



1405003



1405004



1405005

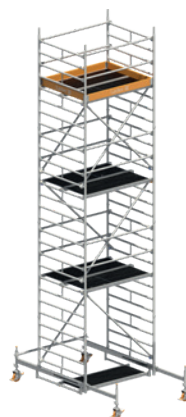

1405006

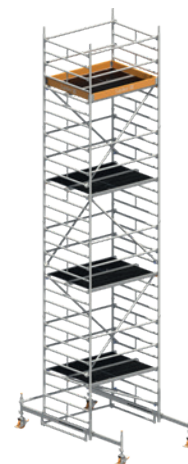

1405007

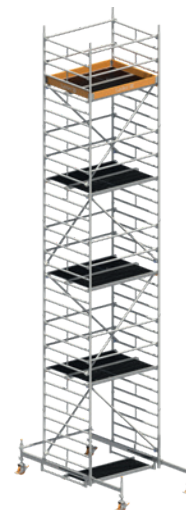

1405008

Tower model	1405001	1405002	1405003	1405004	1405005	1405006	1405007	1405008
Working height [m]	3.20	4.20	5.20	6.20	7.20	8.38	9.38	10.38
Tower height [m]	2.43	3.43	4.43	5.43	6.43	7.61	8.61	9.61
Platform height [m]	1.20	2.20	3.20	4.20	5.20	6.38	7.38	8.38
Weight [kg] (without ballast)	108.3	152.4	191.9	223.9	263.4	377.3	442.5	448.8
<b>Ballasting (stated in units)</b>								
<b>Indoors</b>								
Assembly, central*	0	l1 r1	l1 r1	l4 r4	l4 r4	0	0	l1 r1
Assembly, off-centre	X	X	X	X	X	0	0	l1 r1
Assembly, off-centre with wall bracing	0	l2 r0	l2 r0	l4 r0	l4 r0	0	0	l1 r1
<b>Outdoors</b>								
Assembly, central*	0	l1 r1	l3 r3	l7 r7	l11 r11	l13 r13	l17 r17	X
Assembly, off-centre	X	X	X	X	X	l13 r13	l17 r17	X
Assembly, off-centre with wall bracing	0	l2 r0	l4 r0	l10 r4	l14 r4	l13 r13	l17 r17	X

\* For assembly with adjustable mobile beam, the latter must be fully extended. X = not permissible/not possible 0 = no ballast required For ballasting, use Layer ballast weights, Ref. No. 1249.000, of 10 kg each. The weights are fastened quickly and securely at the right place using the handwheel coupler. All heights stated without possible spindle extension! The max. spindle extension of the relevant assembly variants can be found in the corresponding section! Do not use any liquid or granular ballast substances. The ballast weights must be distributed evenly to all ballasting fixing points.

Example: l2, r2 → Fasten 2 ballast weights of 10 kg each to the ladder frame on its left-hand side, and 2 ballast weights of 10 kg each on its right-hand side.  
 L6, R16 → Fasten 6 ballast weights of 10 kg each to the mobile beam on its left-hand side, and 6 ballast weights of 10 kg each on its right-hand side  
 In the case of off-centre assembly, r and R always relate to the side facing away from the tower; l and L relate to the side facing the tower.



## 1405022 – 1405028 with stabilisers, extendible

For assembly outdoors, comply with the height restriction!

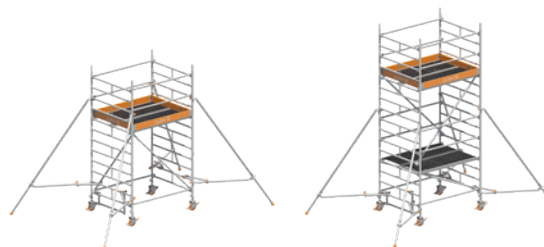
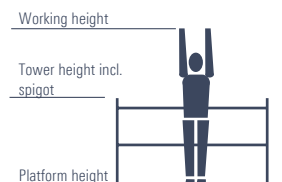

1405022

1405023



1405024

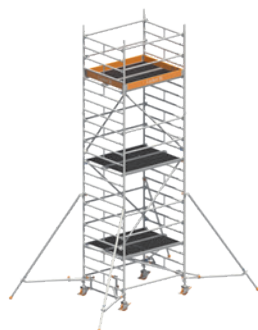

1405025

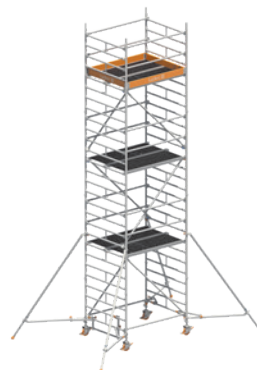

1405026

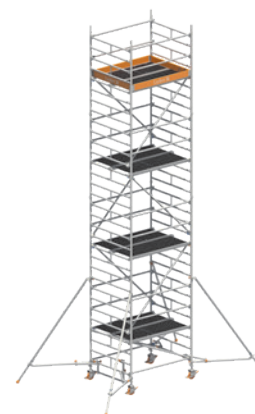

1405027

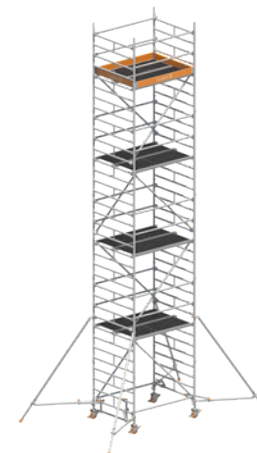

1405028

Tower model	1405022	1405023	1405024	1405025	1405026	1405027	1405028
Working height [m]	4.20	5.20	6.20	7.20	8.20	9.20	10.20
Tower height [m]	3.43	4.43	5.43	6.43	7.43	8.43	9.43
Platform height [m]	2.20	3.20	4.20	5.20	6.20	7.20	8.20
Weight [kg] (without ballast)	181.2	237.3	252.5	308.6	324.0	380.1	395.5
<b>Ballasting</b>							
<b>Indoors</b>							
Assembly, central	0	0	0	0	0	0	0
Assembly, off-centre	0	0	L0 R2	L0 R2	L0 R4	L0 R4	L0 R6
Assembly, off-centre with wall bracing	0	0	0	0	0	0	0
<b>Outdoors</b>							
Assembly, central	0	0	l2 r2	l4 r4	l9 r9	l12 r12	X
Assembly, off-centre	0	L0 R2	L0 R4	L0 R6	L0 R10	L0 R14	X
Assembly, off-centre with wall bracing	0	0	0	0	0	0	X

X = not permissible / not possible 0 = no ballast required For ballasting, use Layher ballast weights, Ref. No. 1249.000, of 10 kg each. The weights are fastened quickly and securely at the right place using the handwheel coupler. All heights stated without possible spindle extension! The max. spindle extension of the relevant assembly variants can be found in the corresponding section! **Do not use any liquid or granular ballast substances.**

**The ballast weights must be distributed evenly to all ballasting fixing points.**

Example: l2, r2 → Fasten 2 ballast weights of 10 kg each to the ladder frame on its left-hand side, and 2 ballast weights of 10 kg each on its right-hand side.  
 L6, R16 → Fasten 6 ballast weights of 10 kg each to the mobile beam on its left-hand side, and 16 ballast weights of 10 kg each on its right-hand side  
 In the case of off-centre assembly, r and R always relate to the side facing away from the tower; l and L relate to the side facing the tower.

### 3.1.3 PARTS LIST

#### Safety Structure P2, Tower models 1405001 – 1405008

Tower model	Ref. No.	1405001	1405002	1405003	1405004	1405005	1405006	1405007	1405008
Guardrail 1.80 m	1205.180	0	6	10	10	14	12	17	16
Double guardrail 1.80 m	1206.180	2	0	0	0	0	0	0	0
Diagonal brace 2.50 m	1208.180	0	2	2	4	4	6	6	8
Diagonal brace 1.95 m	1208.195	0	0	2	0	2	0	2	0
Basic tube 1.80 m	1211.180	0	0	0	0	0	1	1	1
Deck 1.80 m	1241.180	1	2	2	3	3	4	4	5
Access deck 1.80 m	1242.180	1	1	2	2	3	3	4	4
Spring clip	1250.000	0	4	4	8	8	16	16	20
Ladder frame 150/4- 1.00 m	1299.004	0	2	0	2	0	2	0	2
Ladder frame 150/8- 2.00 m	1299.008	2	2	4	4	6	6	8	8
Uni assembly hook	1300.010	0	1	1	1	1	1	1	1
Mobile beam 3.20 m with access ledger, adjustable	1323.320	0	0	0	0	0	2	2	2
Access ledger 0.75 m	1344.003	0	2	1	2	1	0	0	0
Castor 700 - 7 kN	1359.200	4	4	4	4	4	4	4	4
End toe board 1.44 m	1438.144	2	2	2	2	2	2	2	2
Toe board 1.80 m with claw	1439.180	2	2	2	2	2	2	2	2
Ballast	1249.000	For number of ballast weights, see Section 3.1.2: Tower models							

#### Safety Structure P2 with stabiliser, extendable Tower models 1405022 – 1405028

Tower model	Ref. No.	1405022	1405023	1405024	1405025	1405026	1405027	1405028
Guardrail 1.80 m	1205.180	6	10	10	14	14	18	18
Diagonal brace 2.50 m	1208.180	2	2	4	4	6	6	8
Diagonal brace 1.95 m	1208.195	0	2	0	2	0	2	0
Deck 1.80 m	1241.180	1	2	2	3	3	4	4
Access deck 1.80 m	1242.180	1	2	2	3	3	4	4
Aluminium stabiliser, extendable	1248.260	4	4	4	4	4	4	4
Rotation lock	1248.261	4	4	4	4	4	4	4
Spring clip	1250.000	4	4	8	8	12	12	16
Ladder frame 150 / 4 – 1.00	1299.004	2	0	2	0	2	0	2
Ladder frame 150 / 8 – 2.00	1299.008	2	4	4	6	6	8	8
Uni assembly hook	1300.010	1	1	1	1	1	1	1
Access ledger 0.75 m	1344.003	1	1	1	1	1	1	1
Castor 700 – 7 kN	1359.200	4	4	4	4	4	4	4
End toe board 1.44 m	1438.144	2	2	2	2	2	2	2
Toe board 1.80 m with claw	1439.180	2	2	2	2	2	2	2
Ballast	1249.000	For number of ballast weights, see Section 3.1.2: Tower models						



### 3.1.4 ASSEMBLY SEQUENCE SAFETY STRUCTURE P2

Observe the general directions for assembly and use on pages 5 – 7. The assembly examples shown are intended for use up to a maximum platform height of 12 m indoors and up to a maximum platform height of 8 m outdoors. Snap the snap-on claws of all parts into the ladder frames from above. Level the scaffolding structure after basic assembly. This is done using the threaded spindles of the castors.



**The castors must be locked during assembly, modification or dismantling and while there is anybody on the scaffolding structure.**

Hammer home the wedges in the system until the blow bounces off. Always tighten the screw couplers well (50 Nm).

At the top level, instead of two guardrails **18**, it is also possible to fit a double guardrail **19** or a tower beam **22**. In this case, please note that additional guardrails **18** for an entire level must be present for assembly and dismantling in order to ensure collective side protection as required for the employed assembly variant. These can be removed again after inserting the double guardrails **19** or the tower beam **22**.

The **item numbers** for the components relate to the component list on pages 55 – 58.

#### BASIC ASSEMBLY Tower models 1405001



1. Insert the castors **1** in the ladder frames 150/8 **16** and secure them against falling out by tightening the wing screws on the spindle nuts.
2. Connect the two ladder frames 150/8 **16** to two double guardrails **19**. Hook the deck **29** and access deck **28** into the fourth rung from the bottom of the ladder frames 150/8 **16**.

Further assembly is performed as per page 17, "Completing the working platform".

**BASIC ASSEMBLY**  
Tower models  
1405006 and  
1405008



1. Insert the castors **1** into the mobile beams **8/9** and secure them against falling out by tightening the wing screws on the spindle nuts.
2. The mobile beams **8/9** must be connected with a basic tube **10** – or optionally with abasic strut **11** – and a deck **29**.
3. Fit two ladder frames 150/4 **15** on the mobile beams and secure using spring clips **17**.

Further assembly is performed as per page 16, “Assembly of intermediate platforms”.

**BASIC ASSEMBLY**  
Tower models  
1405007

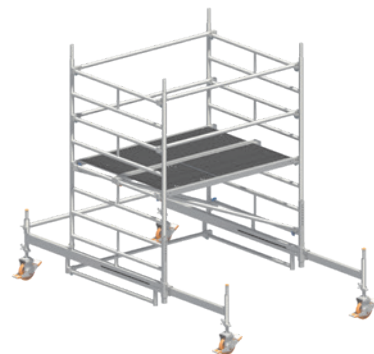

1. Insert the castors **1** into the mobile beams **8/9** and secure them against falling out by tightening the wing screws on the spindle nuts.
2. The mobile beams **8/9** must be connected to one another with a basic tube **10** – or optionally with a basic strut **11** – and a guardrail **18** at the access ledger of the mobile beam.
3. Fit a ladder frame 150/8 **16** on the mobile beam **8/9** and secure it using spring clips **17**. Hook two guardrails **18** at the topmost rung and connect with a second ladder frame 150/8 **16**. Then fit the second ladder frame 150/8 **16** at the mobile beam and secure using spring clips **17**. *Any double guardrails that might be in stock can be installed as side protection for the first level. Remove the guardrails previously installed as advancing side protection again after fitting the double guardrails.*
4. Fit two diagonal braces **24**, a deck **29** and an access deck **28**. **Make sure that a diagonal brace is installed in the direction of the access hatch. Snap the second diagonal brace on the side of the deck in the same direction but with the snap-on claw snapped into the rungs from below.** The two diagonal braces can also optionally be installed in opposite directions, crosswise (not shown).
5. Before going up, fit two additional guardrails **18** as intermediate rails to the second rung above the standing surface, starting from the assembly surface (floor/ground).

Further assembly is performed as per page 16, “Assembly of intermediate platforms”.

## BASIC ASSEMBLY

### Tower models

1405002, 1405004,  
1405022, 1405024,  
1405026, 1405028

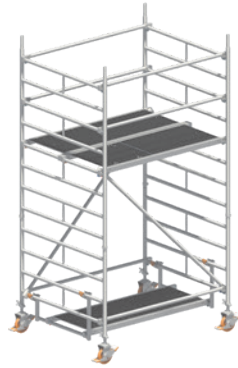

1. Insert the castors **1** in the ladder frames 150/4 **15** and secure them against falling out by tightening the wing screws on the spindle nuts.
2. Fit further ladder frames 150/8 **16**. Connect the two rolling tower side parts at the top rungs and at the bottom rungs with two guardrails **18** in each case.
3. Fit two diagonal braces **23** crosswise. Then hook in a deck **29** and an access deck **28**.
4. To maintain the maximum distance from the first rung, fit an access ledger **12** on the ascent side of the rolling tower.
5. Climb up on the inside using the rungs of the ladder frame and through the access hatch provided. While sitting in the access hatch opening, protected from falling by the sides of the access deck **28**, assemble the intermediate rail of the next level: to do so, fit the guardrails **18** to the second rungs above the standing surface (see also "Assembly of intermediate platforms", item 5).

Further assembly is performed as per page 16, "Assembly of intermediate platforms". Further assembly for model 1405022 is performed as per page 17 "Completing the working platform".

## BASIC ASSEMBLY

### Tower models

1405023, 1405025,  
1405027



1. Insert the castors **1** in the ladder frames 150/8 **16** and secure them against falling out by tightening the wing screws on the spindle nuts.
2. Connect the two rolling tower side parts at the top rungs and at the bottom rungs with two guardrails **18** in each case.
3. Fit two diagonal braces **24**, a deck **29** and an access deck **28**. **Make sure that a diagonal brace is installed in the direction of the access hatch. Snap the second diagonal brace on the side of the deck in the same direction but with the snap-on claw snapped into the rungs from below.** The two diagonal braces can also optionally be installed in opposite directions, crosswise (not shown).
4. To maintain the maximum distance from the first rung, fit an access ledger **12** on the ascent side of the rolling tower.
5. Before going up, fit two additional guardrails **18** as intermediate rails to the second rung above the standing surface, starting from the assembly surface (floor/ground).

Further assembly is performed as per page 16, "Assembly of intermediate platforms".

## ASSEMBLY OF INTERMEDIATE PLATFORMS

### All tower models with Safety Structure P2

**i** Repeat the following assembly steps 1 to 5 several times depending on the assembly height.

1. Mount the first ladder frame 150/8 **16** and secure it using spring clips **17**.



2. Attach the Uni assembly hooks **30** and position the second ladder frame 150/ 8 **16** in order to fit the guardrails **18**.

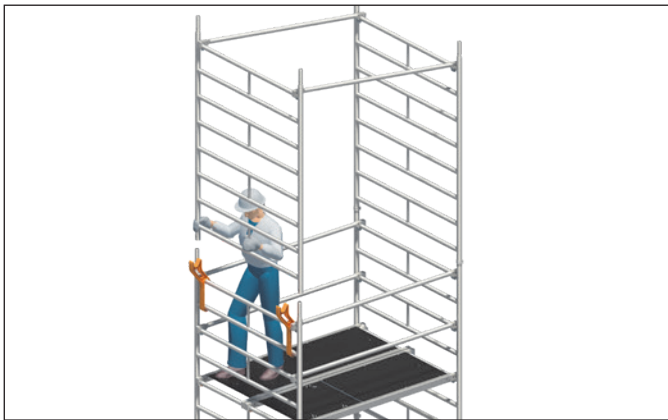

3. Swivel the ladder frame 150/8 **16** with guardrails **18** upwards, fit it in place and secure it with spring clips **17**.

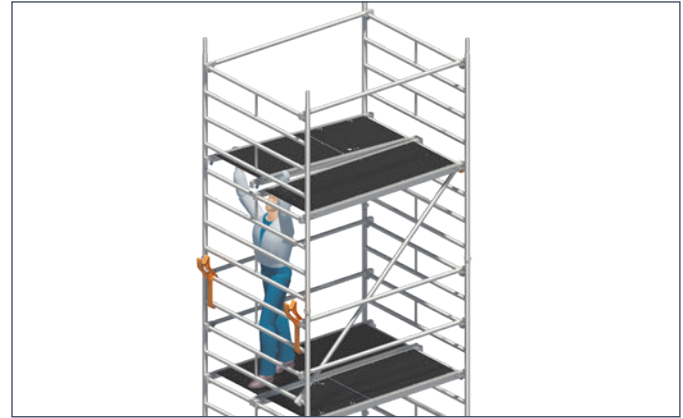

4. Insert diagonal braces **23**, deck **29** and access deck **28**. Install the diagonal braces on both sides in tower-like form (so that they zig-zag).



5. Climb up on the inside using the rungs of the ladder frame and through the access hatch provided. While sitting in the access hatch opening, protected from falling by the sides of the access deck **28**, assemble the intermediate rail of the next level: to do so, fit the guardrails **18** to the second rungs above the standing surface.

## COMPLETING THE WORKING PLATFORM

All tower models for creating the required working platform

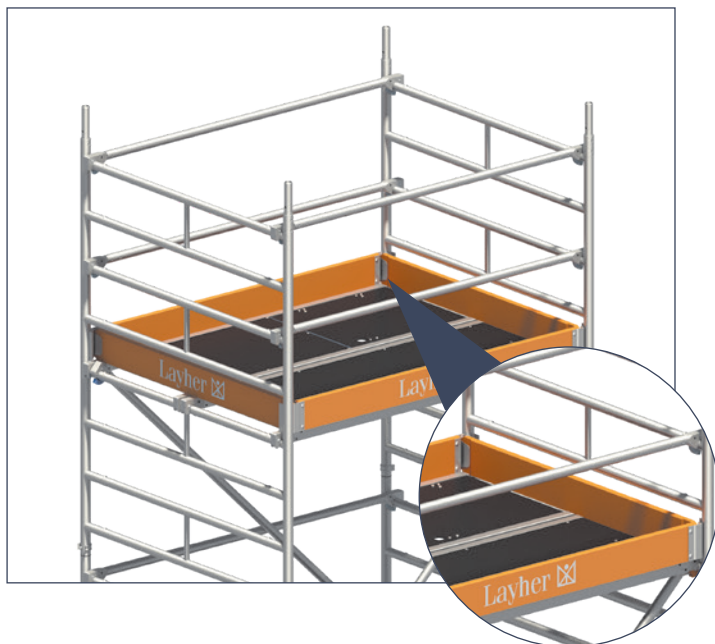

To complete the working platform, attach toe boards with claw **31** and end toe board 150 **32**.



If an intermediate platform is used as a working platform, it is also necessary to attach toe boards here.

### 3.1.5 DISMANTLING SEQUENCE SAFETY STRUCTURE P2

 Repeat the following dismantling steps 1 to 7/14 several times depending on the assembly height.

Dismantling is performed in the reverse order to assembly.

**When dismantling, do not remove the bracing elements such as diagonal braces, guardrails or access decks until the ladder frames above them have been dismantled.**

To lift out the individual parts, open the snap-on claws by pressing their locking clips.

1. Dismantle the toe boards **31/32** (only necessary on the working platform).



2. Dismantle the intermediate rails of the relevant level while sitting in the trapdoor opening, protected from falls by the sides of the access deck **28**. To do this, remove the guardrails **18** at the second rungs above the standing surface. If the snap-on claws of the guardrails **18** are not reachable from the sitting position in the access hatch opening, dismantle as described in **8**. below.



3. Dismantle the access deck **28** and diagonal braces **23**.
4. Attach the Uni assembly hooks **30** at the side of the access hatch opening above and remove the spring clips **17** on one side.
5. Lift out the ladder frame **150/8 16** on the side of the Uni assembly hooks, swivel downwards with the guardrail and position in the previously mounted Uni assembly hooks **30**.



6. Detach the guardrails on one side **18** from the positioned ladder frame.



7. Dismantle the guardrails **18** by opening the snap-on claw using one of the intermediate rails dismantled under point **2**. Place the loose guardrail **18** from above onto the second rung and use it as a lever for opening the snap-on claw (see detail).

## ALTERNATIVE DISMANTLING SEQUENCE



8. While sitting in the access hatch opening, protected from falling by the sides of the access deck **28**, dismantle and put down the snap-on claws of both handrails on one side, the side of the access hatch, 1 metre above the standing surface.
9. After climbing down to the platform underneath, dismantle the deck **29**, the access deck **28** and the diagonal braces **23**.
10. Attach the Uni assembly hooks **30** at the side of the access hatch opening above and remove the spring clips **17** on one side.







11. Lift out the ladder frame 150/8 **16** on the Uni assembly hook side and swivel it downwards with the handrails released on one side under **8**. and with the still attached intermediate rails, in order to position this unit into the previously fitted Uni assembly hooks **30**. When swivelling it down, make sure that the guardrails **18** released on one side at the top rung of the ladder frame are able to slide outwards, allowing the complete unit to be positioned in the Uni assembly hooks **30**.



12. Moving the upper guardrails **18**, already released on one side, on the outside past the upper ends of the ladder frame positioned in the Uni assembly hooks **30** allows these to be positioned for later dismantling.





13. Using the end toe board or a guardrail additionally available, to act as extensions, release the locking clip of the snap-on claws on one of the still attached intermediate rails or guardrails **18** about 2.5 metres up in order to lift out the snap-on claw on one side. After that, release the guardrail **18** released on one side, at the side in which it is positioned in the Uni assembly hooks **30**, and remove it by rotating it 90° about its own axis.



14. Lift out the second remaining intermediate rail or guardrail **18** on one side, the side in which it is positioned in the Uni assembly hooks, and swivel the ladder frame 150/8 **16** into the Uni assembly hooks **30** into a vertical position, so that the three guardrails **18** still remaining can then be removed using the guardrail **18** already removed under **8**. as an extension. Place the loose guardrail **18** onto the rung underneath, for use as a lever to open the locking clip of the snap-on claw (see detail).

## 3.2 ROLLING TOWERS WITH SAFETY STRUCTURE P2 WITH UNI TELESCOPING GUARD-

### RAIL

#### 3.2.1 FALL PROTECTION MEASURES

Suitable measures for fall protection must be taken during assembly, modification or dismantling of the scaffolding structure. Safety Structure P2 with Uni telescoping guardrail implements these protective measures in full.

#### Safety Structure P2 with Uni telescoping guardrail

- ▶ Platforms with a vertical spacing of 2 m.
- ▶ Safer design with integrated, collective and advancing side protection.

Thanks to the platforms, which are assembled 2-m apart, both the handrails and the intermediate rails (Uni telescoping guardrails) can be fitted from the level underneath, so that when the next platform up is accessed there is already a double side protection in place on all sides.





**1.** Attach the first ladder frame. Attach the Uni assembly hooks and position the second ladder frame in order to fit the guardrails as well as the Uni telescoping guardrails as intermediate rails.



**2.** Swivel the ladder frame with the guardrails and Uni telescoping guardrails upwards and mount on the ladder frame underneath.

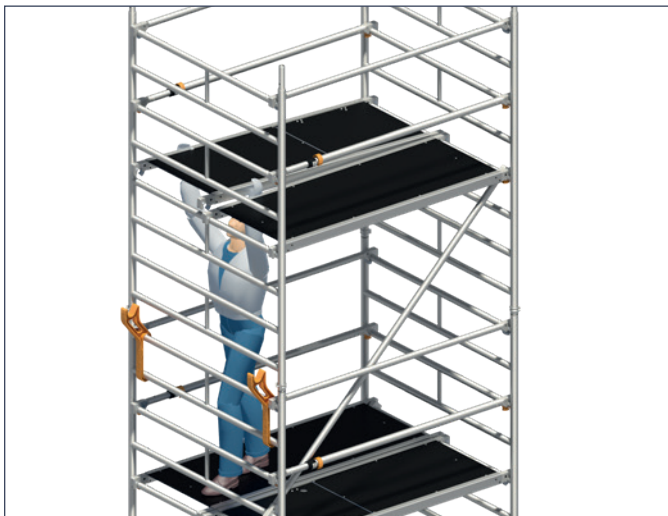

**3.** Insert diagonal braces, deck and access deck.

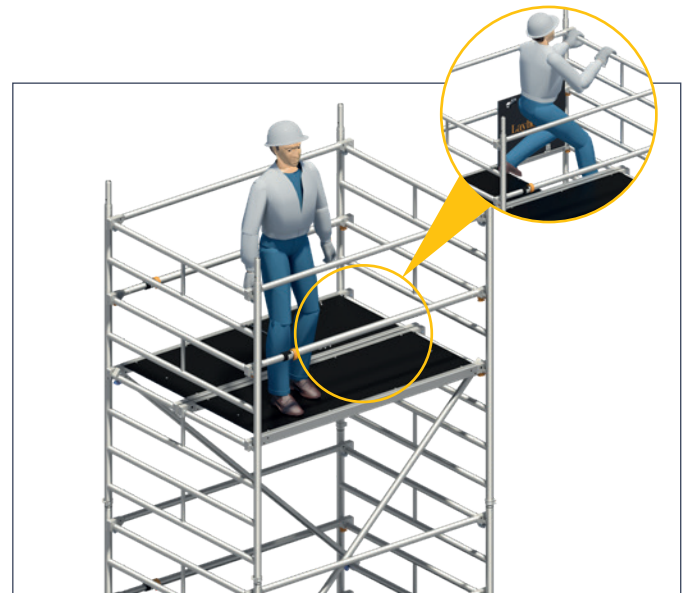

**4.** Access to the now secured level.

## 3.2.2 TOWER MODELS

### 1415002 – 1415008

For assembly outdoors, comply with the height restriction!

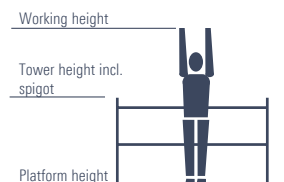

1405001: no Safety Structure  
P2 required – see Section 3.1.2



1415002



1415003



1415004



1415005



1415006

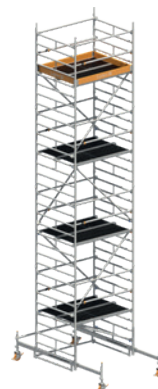

1415007

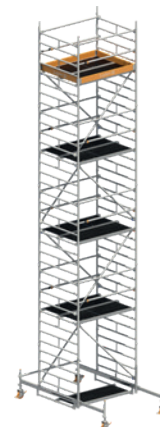

1415008

Tower model	1415002	1415003	1415004	1415005	1415006	1415007	1415008
Working height [m]	4.20	5.20	6.20	7.20	8.38	9.38	10.38
Tower height [m]	3.43	4.43	5.43	6.43	7.61	8.61	9.61
Platform height [m]	2.20	3.20	4.20	5.20	6.38	7.38	8.38
Weight [kg] (without ballast)	155.7	198.3	230.3	272.9	386.8	435.0	461.4
<b>Ballasting (stated in units)</b>							
<b>Indoors</b>							
Assembly, central*	l1 r1	l1 r1	l4 r4	l4 r4	0	0	l1 r1
Assembly, off-centre	X	X	X	X	0	0	l1 r1
Assembly, off-centre with wall bracing	l2 r0	l2 r0	l4 r0	l4 r0	0	0	l1 r1
<b>Outdoors</b>							
Assembly, central*	l1 r1	l3 r3	l7 r7	l11 r11	l13 r13	l17 r17	X
Assembly, off-centre	X	X	X	X	l13 r13	l17 r17	X
Assembly, off-centre with wall bracing	l2 r0	l4 r0	l10 r4	l14 r4	l13 r13	l17 r17	X

\* For assembly with adjustable mobile beam, the latter must be fully extended. X = not permissible / not possible 0 = no ballast required For ballasting, use Layher ballast weights, Ref. No. 1249.000, of 10 kg each. The weights are fastened quickly and securely at the right place using the handwheel coupler. All heights stated without possible spindle extension! The max. spindle extension of the relevant assembly variants can be found in the corresponding section! Do not use any liquid or granular ballast substances. The ballast weights must be distributed evenly to all ballasting fixing points.

Example: l2, r2 → Fasten 2 ballast weights of 10 kg each to the ladder frame on its left-hand side, and 2 ballast weights of 10 kg each on its right-hand side.  
l6, R16 → Fasten 6 ballast weights of 10 kg each to the mobile beam on its left-hand side, and 16 ballast weights of 10 kg each on its right-hand side  
In the case of off-centre assembly, r and R always relate to the side facing away from the tower; l and L relate to the side facing the tower.

## 1415022 – 1415028

with Uni telescoping guardrail and stabilisers, extendible

For assembly outdoors, comply with the height restriction!

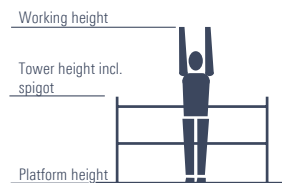

1415022



1415023



1415024

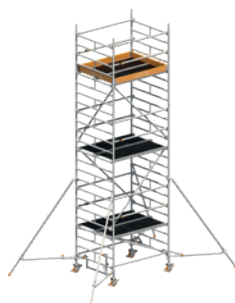

1415025



1415026



1415027

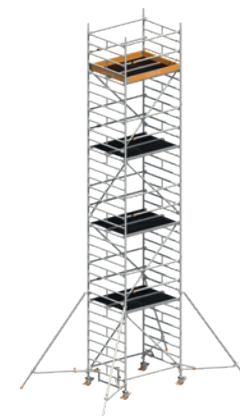

1415028

Tower model	1415022	1415023	1415024	1415025	1415026	1415027	1415028
Working height [m]	4.20	5.20	6.20	7.20	8.20	9.20	10.20
Tower height [m]	3.43	4.43	5.43	6.43	7.43	8.43	9.43
Platform height [m]	2.20	3.20	4.20	5.20	6.20	7.20	8.20
Weight [kg] (without ballast)	184.3	243.5	258.9	318.1	333.5	392.7	408.1
<b>Ballasting (stated in units)</b>							
<b>Indoors</b>							
Assembly, central	0	0	0	0	0	0	0
Assembly, off-centre	0	0	L0 R2	L0 R2	L0 R4	L0 R4	L0 R6
Assembly, off-centre with wall bracing	0	0	0	0	0	0	0
<b>Outdoors</b>							
Assembly, central	0	0	l2 r2	l4 r4	l9 r9	l12 r12	X
Assembly, off-centre	0	L0 R2	L0 R4	L0 R6	L0 R10	L0 R14	X
Assembly, off-centre with wall bracing	0	0	0	0	0	0	X

X = not permissible / not possible 0 = no ballast required For ballasting, use Layher ballast weights, Ref. No. 1249.000, of 10 kg each. The weights are fastened quickly and securely at the right place using the handwheel coupler. All heights stated without possible spindle extension! The max. spindle extension of the relevant assembly variants can be found in the corresponding section! **Do not use any liquid or granular ballast substances. The ballast weights must be distributed evenly to all ballasting fixing points.**

Example: l2, r2 → Fasten 2 ballast weights of 10 kg each to the ladder frame on its left-hand side, and 2 ballast weights of 10 kg each on its right-hand side.  
 l6, R16 → Fasten 6 ballast weights of 10 kg each to the mobile beam on its left-hand side, and 16 ballast weights of 10 kg each on its right-hand side  
 In the case of off-centre assembly, r and R always relate to the side facing away from the tower; l and L relate to the side facing the tower.

### 3.2.3 PARTS LIST

#### Safety Structure P2 with Uni Telescoping Guardrail, Tower models 1415002 – 1415008

Tower model	Ref. No.	1415002	1415003	1415004	1415005	1415006	1415007	1415008
Uni telescoping guardrail	1204.180	2	4	4	6	6	8	8
Guardrail 1.80 m	1205.180	4	6	6	8	6	9	8
Diagonal brace 2.50 m	1208.180	2	2	4	4	6	6	8
Diagonal brace 1.95 m	1208.195	0	2	0	2	0	2	0
Basic tube 1.80 m	1211.180	0	0	0	0	1	1	1
Deck 1.80 m	1241.180	2	2	3	3	4	4	5
Access deck 1.80 m	1242.180	1	2	2	3	3	4	4
Spring clip	1250.000	4	4	8	8	16	16	20
Ladder frame 150/4- 1.00 m	1299.004	2	0	2	0	2	0	2
Ladder frame 150/8- 2.00 m	1299.008	2	4	4	6	6	8	8
Uni assembly hook	1300.010	1	1	1	1	1	1	1
Mobile beam with access ledger, adjustable	1323.320	0	0	0	0	2	2	2
Access ledger 0.75 m	1344.003	2	1	2	1	0	0	0
Castor 700	1359.200	4	4	4	4	4	4	4
End toe board	1438.144	2	2	2	2	2	2	2
Toe board with claw	1439.180	2	2	2	2	2	2	2
Ballast	1249.000	Number of ballast weights, see Section 3.2.2: Tower models						

#### Safety Structure P2 with Uni Telescoping Guardrail with stabiliser, extendable Tower models 1415022 – 1415028

Tower model	Ref. No.	1415022	1415023	1415024	1415025	1415026	1415027	1415028
Uni telescoping guardrail	1204.180	2	4	4	6	6	8	8
Guardrail 1.80 m	1205.180	4	6	6	8	8	10	10
Diagonal brace 2.50 m	1208.180	2	2	4	4	6	6	8
Diagonal brace 1.95 m	1208.195	0	2	0	2	0	2	0
Deck 1.80 m	1241.180	1	2	2	3	3	4	4
Access deck 1.80 m	1242.180	1	2	2	3	3	4	4
Stabiliser, extendible	1248.260	4	4	4	4	4	4	4
Rotation lock for stabiliser	1248.261	4	4	4	4	4	4	4
Spring clip	1250.000	4	4	8	8	12	12	16
Ladder frame 150/4- 1.00 m	1299.004	2	0	2	0	2	0	2
Ladder frame 150/8- 2.00 m	1299.008	2	4	4	6	6	8	8
Uni assembly hook	1300.010	1	1	1	1	1	1	1
Access ledger 0.75 m	1344.003	1	1	1	1	1	1	1
Castor 700	1359.200	4	4	4	4	4	4	4
End toe board	1438.144	2	2	2	2	2	2	2
Toe board with claw	1439.180	2	2	2	2	2	2	2
Ballast	1249.000	Number of ballast weights, see Section 3.2.2: Tower models						

### 3.2.4 ASSEMBLY SEQUENCE SAFETY ASSEMBLY P2 WITH UNI TELESCOPING GUARDRAIL

Observe the general directions for assembly and use on pages 5 – 7. The assembly examples shown are intended for use up to a maximum platform height of 12 m indoors and up to a maximum platform height of 8 m outdoors. Unless explicitly stated in the text, snap-on claws should generally be snapped onto the ladder frames from above. Level the scaffolding structure after basic assembly. This is done using the threaded spindles of the castors.



**The castors must be locked during assembly, modification or dismantling and while there is anybody on the scaffolding structure.**

Hammer home the wedges in the system until the blow bounces off. Always tighten the screw couplers well (50 Nm).

At the top level, instead of two guardrails **18**, it is also possible to fit a double guardrail **19** or a tower beam **22**. Please remember in this case that two additional guardrails **18** and two additional Uni telescoping guardrails **21** must be provided for assembly and dismantling in order to ensure collective two-part side protection. These can be removed again after inserting the double guardrails **19** or the tower beams **22**.

The **item numbers** for the components relate to the component list on pages 55 – 58.

#### BASIC ASSEMBLY Tower models 1415006 and 1415008



1. Insert the castors **1** into the mobile beams **8/9** and secure them against falling out by tightening the wing screws on the spindle nuts.
2. The mobile beams **8/9** must be connected with a basic tube **10** – or optionally with a basic strut **11** – and a deck **29**.
3. Fit two ladder frames 150/4 **15** on the mobile beams and secure using spring clips **17**.

Further assembly is performed as per page 30, “Assembly of intermediate platforms”.



## BASIC ASSEMBLY

### Tower models 1415007



1. Insert the castors **1** into the mobile beams **8/9** and secure them against falling out by tightening the wing screws on the spindle nuts.
2. The mobile beams **8/9** must be connected to one another with a basic tube **10** – or optionally with a basic strut **11** – and a guardrail **18** at the access ledger of the mobile beam.
3. Fit a ladder frame **150/8 16** on the mobile beam **8/9** and secure it using spring clips **17**. Hook two guardrails **18** at the topmost rung and connect with a second ladder frame **150/8 16**. Hook in two Uni telescoping guardrails **21**, both two rungs below the guardrails **18** and connect these to the second ladder frame **150/8 16** at the corresponding rung.. Then swivel the second ladder frame **150/8 16** upwards, mount it on the mobile beam and secure it with spring clips **17**. *Any double guardrails **19** that might be in stock can be installed as side protection for the first platform. In this case, assembly can be performed from the assembly surface (floor) with ladder frames **150/8 16** mounted on both sides.*
4. Fit two diagonal braces **24**, a deck **29** and an access deck **28**. **Make sure that a diagonal brace is installed in the direction of the access hatch. Snap the second diagonal brace on the side of the deck in the same direction but with the snap-on claw snapped into the rungs from below.** The two diagonal braces can also optionally be installed in opposite directions, crosswise (not shown).

Further assembly is performed as per page 30, “Assembly of intermediate platforms”.

## BASIC ASSEMBLY

### Tower models 1415002, 1415004, 1415022, 1415024, 1415026 and 1415028



1. Insert the castors **1** in the ladder frames **150/4 15** and secure them against falling out by tightening the wing screws on the spindle nuts.
2. Mount a ladder frame **150/8 16** on one side and secure it with spring clips **17**. To brace the structure, install the first diagonal brace **23** from the fourth rung from the bottom of ladder frame **150/8 16** to the bottommost rung of the ladder frame **150/4 15** opposite.
3. Hook two guardrails **18** at the topmost rung and connect with a second ladder frame **150/8 16**. Hook in two Uni telescoping guardrails **21**, both two rungs below the guardrails **18**, and connect these to the second ladder frame **150/8 16** at the corresponding rung. Then swivel the second ladder frame **150/8 16** upwards, mount it on the second ladder frame **150/4 15** and secure it using spring clips **17**.
4. Hook in the access deck **28** and deck **29** and install the second diagonal brace **23** crosswise to the one that is already installed.
5. To maintain the maximum distance from the first rung, fit an access ledger **12** on the ascent side of the rolling tower.

Further assembly is performed as per page 30, “Assembly of intermediate platforms”. Further assembly for model 1415022 is performed as per page 31 “Completing the working platform”.



## BASIC ASSEMBLY

### Tower models

1415023,  
1415025 and  
1415027



1. Insert the castors **1** in the ladder frames 150/8 **16** and secure them against falling out by tightening the wing screws on the spindle nuts.
2. Position a ladder frame 150/8 **16**, hook in two guardrails **18** at the topmost rung and connect to a second ladder frame 150/8 **16**. Hook in two Uni telescoping guardrails **21**, both two rungs below the guardrails **18**, and connect these to the second ladder frame 150/8 **16** at the corresponding rung. Then position the second ladder frame 150/8 **16** parallel to the first ladder frame and brace using the two short diagonal braces **24**. **Make sure that a diagonal brace is installed in the direction of the access hatch. Snap the second diagonal brace on the side of the deck in the same direction but with the snap-on claw snapped into the rungs from below.** The two diagonal braces can also optionally be installed in opposite directions, crosswise (not shown). *Any double guardrails **19** that might be in stock should be installed as side protection for the first platform. In this case, assembly can be performed from the assembly surface (ground) with the ladder frames fitted on both sides.*
3. Fit two guardrails **18** at the bottommost rung of the ladder frames and fit a deck **29** and an access deck **28** at the fourth rung from the bottom.
4. To maintain the maximum distance from the first rung, fit an access ledger **12** on the ascent side of the rolling tower.

Further assembly is performed as per page 30, "Assembly of intermediate platforms".

## ASSEMBLY OF INTERMEDIATE PLATFORMS

All tower models with Safety Structure P2  
with Uni telescoping guardrail

**i** Repeat the following assembly steps 1 to 5 several times depending on the assembly height.

1. Mount the first ladder frame 150/8 **16** and secure using spring clips **17**.



2. Attach the Uni assembly hooks **30** and position the second ladder frame 150/8 **16**. Hook in two guardrails **18**, each at the top rung of the corresponding mounted ladder frame 150/8 **16** and connect it to a second ladder frame 150/8 **16**. Hook in two Uni telescoping guardrails **21**, both two rungs below the guardrails **18**, and connect these to the second ladder frame 150/8 **16** at the corresponding rung.



3. Swivel the second ladder frame 150/8 **16** together with the pre-assembled side protection upwards and secure using spring clips **17**.



4. Insert both diagonal braces **23**, a deck **29** and the access deck **28**.

*Make sure that the diagonal braces **23** cross over one another and ascend as a tower-like structure (in a zig-zag) on both sides.*

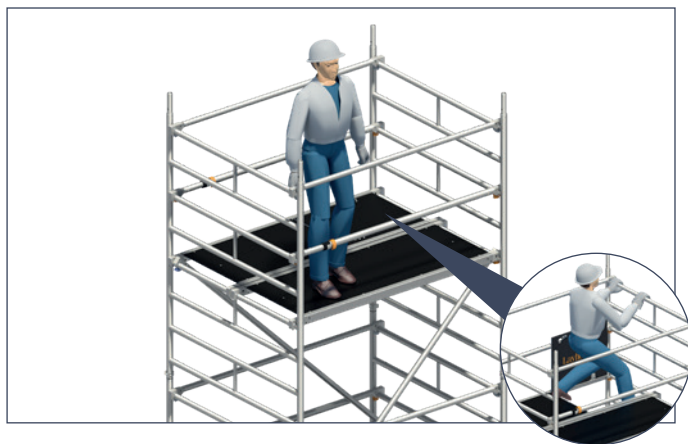

5. Move onto the next platform up, which is already completely secured by means of two-part side protection.

## COMPLETING THE WORKING PLATFORM

All tower models for creating the required working platform

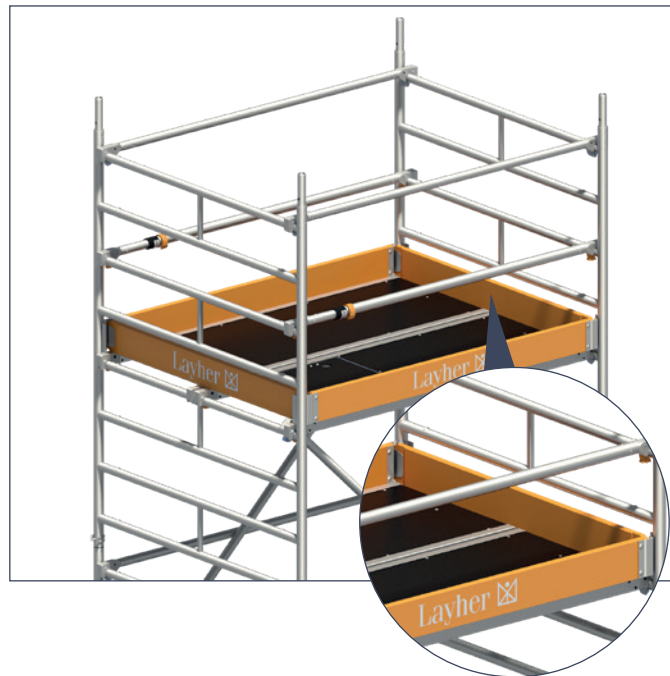

To complete the working platform, attach toe boards with claw **31** and end toe board **33**.



If an intermediate platform is used as a working platform, it is also necessary to attach toe boards here.

### 3.2.5 ASSEMBLY SEQUENCE SAFETY STRUCTURE P2 WITH UNI TELESCOPING GUARDRAIL

 Repeat the following dismantling steps 1 to 6 several times depending on the assembly height.

Dismantling is performed in the reverse order to assembly.

**When dismantling, do not remove the bracing elements such as diagonal braces, guardrails, decks or access decks until the ladder frames above them have been dismantled.**

To lift out the individual parts, open the snap-on claws by pressing their locking clips.

1. Dismantle the toe boards **31/32** (only necessary on the working platform).
2. Before coming down, make sure that the plastic spring clips of the Uni telescoping guardrails **21** are released so that the guardrail is able to telescope (see detailed images).

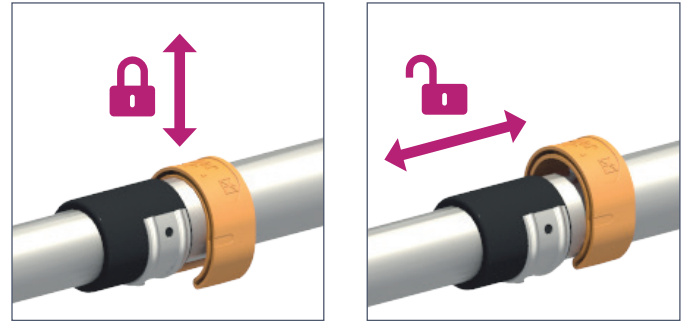

3. After climbing down to the platform underneath, dismantle the access deck **28**, the deck **29** and the diagonal braces **23**.
4. Attach the Uni assembly hooks **30** on one side and remove the spring clips **17** on the same side.



5. Lift out the ladder frame 150/8 **16** on the Uni assembly hook side, swing downwards together with the still assembled side protection and position in the Uni assembly hooks **30**.



6. Dismantle the side protection. Release all the snap-on claws of the Uni telescoping guardrails **21** and the guardrails **18** from the rungs of the ladder frame 150/8 **16** on the side positioned in the Uni assembly hooks **30**. All the guardrails can be left suspended at the opposite ladder frame 150/8 **16** and remain there until the ladder frame positioned in the Uni assembly hook **30** has been secured against falling or tipping. The side protection can then be completely dismantled. Use an end toe board 150 **32** or an additionally available guardrail **18**, as an extension to release the locking clips of the snap-on claws of the Uni telescoping guardrails **21** at a height of approx. 2.5 metres in order to make it possible to lift the snap-on claws out of the rungs. Next, dismantle the guardrail **18** fitted above it in the same way.

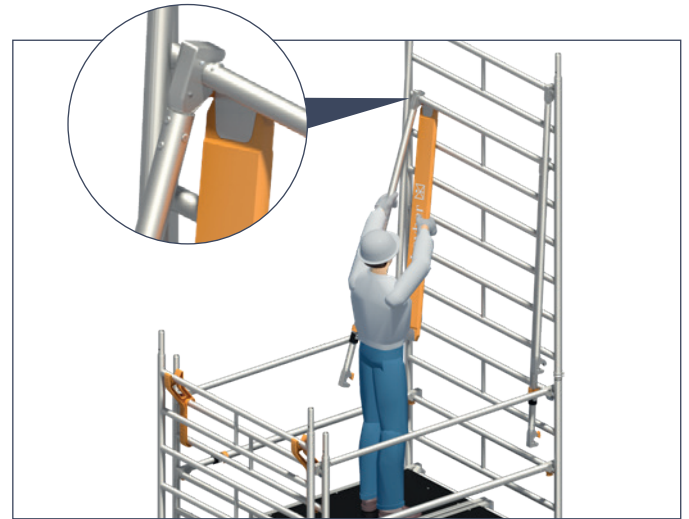



## 3.3 ROLLING TOWERS WITH SAFETY STRUCTURE P2 SAFETY<sup>PLUS</sup> WITH DOUBLE GUARDRAIL

### 3.3.1 FALL PROTECTION MEASURES

Suitable measures for fall protection must be taken during assembly, modification or dismantling of the scaffolding structure. Safety Structure P2 SAFETY<sup>PLUS</sup> with double guardrail implements these protective measures in full.

#### Safety Structure P2 SAFETY<sup>PLUS</sup> with double guardrail

- ▶ Platforms with a vertical spacing of 2 m.
- ▶ Safer design with integrated, collective and advancing side protection.

Thanks to the platforms, which are assembled 2-m apart, the necessary side protection can only be assembled and dismantled from the already secured level below. There is no other way of performing these operations, meaning that when personnel access and leave the next platform up, this already has two-part side protection on all sides.





**1.** Attach the first ladder frame. Attach the Uni assembly hooks and position the second ladder frame in order to fit the double guardrail on both sides.

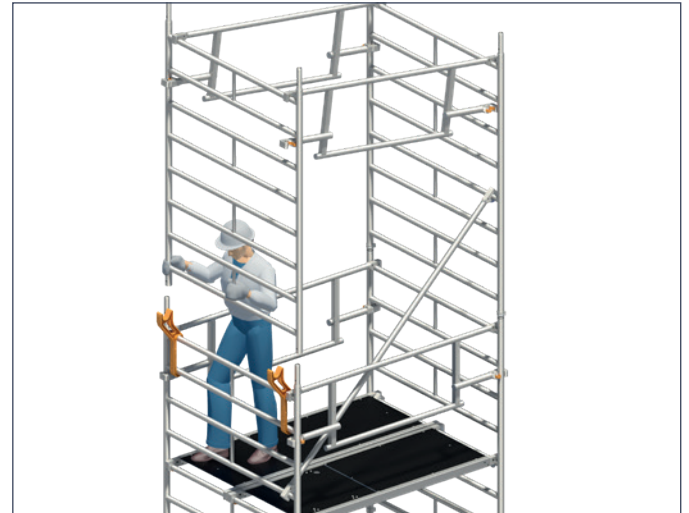

**2.** Swivel the ladder frame with double guardrail upwards and fit it on the ladder frame below.

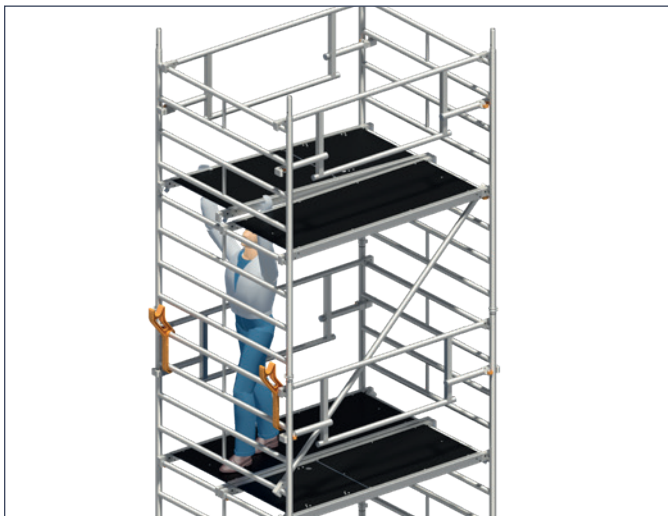

**3.** Insert diagonal braces, deck and access deck.



**4.** Move up to the already secured level and finish by snapping the dual guardrail (lower snap-on claws) into the ladder frame.

## 3.3.2 TOWER MODELS

### 1425001 – 1425008

For assembly outdoors, comply with the height restriction!

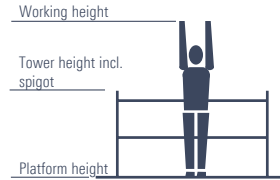

1425001



1425002



1425003



1425004

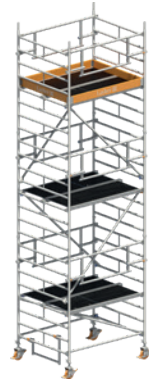

1425005

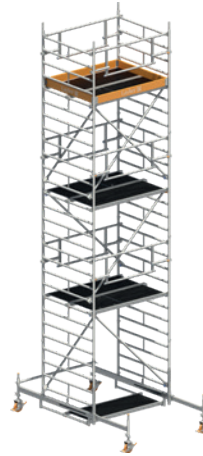

1425006

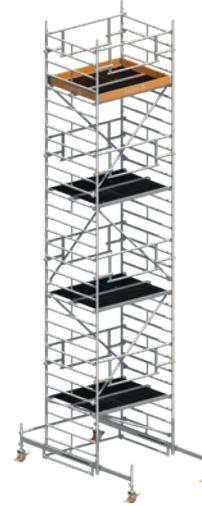

1425007

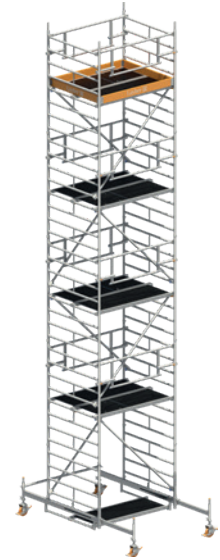

1425008

Tower model	1425001	1425002	1425003	1425004	1425005	1425006	1425007	1425008
Working height [m]	3.20	4.20	5.20	6.20	7.20	8.38	9.38	10.38
Tower height [m]	2.43	3.43	4.43	5.43	6.43	7.61	8.61	9.61
Platform height [m]	1.20	2.20	3.20	4.20	5.20	6.38	7.38	8.38
Weight [kg] (without ballast)	109.5	156.2	199.3	231.3	274.4	388.3	437.0	463.4
<b>Ballasting (stated in units)</b>								
<b>Indoors</b>								
Assembly, central*	0	l1 r1	l1 r1	l4 r4	l4 r4	0	0	l1 r1
Assembly, off-centre	X	X	X	X	X	0	0	l1 r1
Assembly, off-centre with wall bracing	0	l2 r0	l2 r0	l4 r0	l4 r0	0	0	l1 r1
<b>Outdoors</b>								
Assembly, central*	0	l3 r3	l7 r7	l11 r11	l13 r13	l17 r17	X	X
Assembly, off-centre	X	X	X	X	l13 r13	l17 r17	X	X
Assembly, off-centre with wall bracing	0	l4 r0	l10 r4	l14 r4	l13 r13	l17 r17	X	X

\* For assembly with adjustable mobile beam, the latter must be fully extended. X = not permissible/not possible 0 = no ballast required For ballasting, use Layer ballast weights, Ref. No. 1249.000, of 10 kg each. The weights are fastened quickly and securely at the right place using the handwheel coupler. All heights stated without possible spindle extension! The max. spindle extension of the relevant assembly variants can be found in the corresponding section! Do not use any liquid or granular ballast substances. The ballast weights must be distributed evenly to all ballasting fixing points.

Example: l2, r2 → Fasten 2 ballast weights of 10 kg each to the ladder frame on its left-hand side, and 2 ballast weights of 10 kg each on its right-hand side.  
l6, R16 → Fasten 6 ballast weights of 10 kg each to the mobile beam on its left-hand side, and 6 ballast weights of 10 kg each on its right-hand side  
In the case of off-centre assembly, r and R always relate to the side facing away from the tower; l and L relate to the side facing the tower.



## 1425022 – 1425028

with double guardrail and stabilisers, extendible

For assembly outdoors, comply with the height restriction!

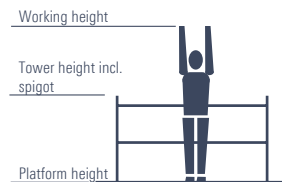

1425022

1425023



1425024

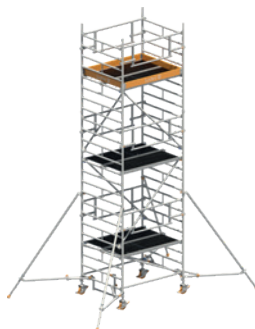

1425025



1425026



1425027

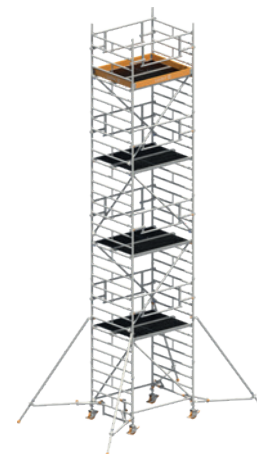

1425028

Tower model	1425022	1425023	1425024	1425025	1425026	1425027	1425028
Working height [m]	4.20	5.20	6.20	7.20	8.20	9.20	10.20
Tower height [m]	3.43	4.43	5.43	6.43	7.43	8.43	9.43
Platform height [m]	2.20	3.20	4.20	5.20	6.20	7.20	8.20
Weight [kg] (without ballast)	184.8	244.5	259.9	319.6	335.0	394.7	410.1
<b>Ballasting (stated in units)</b>							
<b>Indoors</b>							
Assembly, central	0	0	0	0	0	0	0
Assembly, off-centre	0	0	L0 R2	L0 R2	L0 R4	L0 R4	L0 R6
Assembly, off-centre with wall bracing	0	0	0	0	0	0	0
<b>Outdoors</b>							
Assembly, central	0	I2 r2	I4 r4	I9 r9	I12 r12	X	X
Assembly, off-centre	L0 R2	L0 R4	L0 R6	L0 R10	L0 R14	X	X
Assembly, off-centre with wall bracing	0	0	0	0	0	X	X

X = not permissible / not possible 0 = no ballast required For ballasting, use Layher ballast weights, Ref. No. 1249.000, of 10 kg each. The weights are fastened quickly and securely at the right place using the handwheel coupler. All heights stated without possible spindle extension! The max. spindle extension of the relevant assembly variants can be found in the corresponding section! **Do not use any liquid or granular ballast substances. The ballast weights must be distributed evenly to all ballasting fixing points.**

Example: I2, r2 → Fasten 2 ballast weights of 10 kg each to the ladder frame on its left-hand side, and 2 ballast weights of 10 kg each on its right-hand side.  
 L6, R16 → Fasten 6 ballast weights of 10 kg each to the mobile beam on its left-hand side, and 16 ballast weights of 10 kg each on its right-hand side  
 In the case of off-centre assembly, r and R always relate to the side facing away from the tower; l and L relate to the side facing the tower.

### 3.3.3 PARTS LIST

#### Safety Structure P2 SAFETY<sup>PLUS</sup> with double guardrail, Tower models 1425001 – 1425008

Tower model	Ref. No.	1425001	1425002	1425003	1425004	1425005	1425006	1425007	1425008
Guardrail 1.80 m	1205.180	0	2	2	2	2	0	1	0
Diagonal brace 2.50 m	1208.180	0	2	2	4	4	6	6	8
Diagonal brace 1.95 m	1208.195	0	0	2	0	2	0	2	0
Basic tube 1.80 m	1211.180	0	0	0	0	0	1	1	1
Safety double guardrail	1216.180	2	2	4	4	6	6	8	8
Deck 1.80 m	1241.180	1	2	2	3	3	4	4	5
Access deck 1.80 m	1242.180	1	1	2	2	3	3	4	4
Spring clip	1250.000	0	4	4	8	8	16	16	20
Ladder frame 150/4- 1.00 m	1299.004	0	2	0	2	0	2	0	2
Ladder frame 150/8- 2.00 m	1299.008	2	2	4	4	6	6	8	8
Uni assembly hook	1300.010	0	1	1	1	1	1	1	1
Mobile beam with access ledger, adjustable	1323.320	0	0	0	0	0	2	2	2
Access ledger 0.75 m	1344.003	0	2	1	2	1	0	0	0
Castor 700	1359.200	4	4	4	4	4	4	4	4
End toe board	1438.144	2	2	2	2	2	2	2	2
Toe board with claw	1439.180	2	2	2	2	2	2	2	2
Ballast	1249.000	For number of ballast weights, see Section 3.3.2: Tower models							

#### Safety Structure P2 SAFETY<sup>PLUS</sup> with double guardrail with stabiliser, extendable Tower models 1425022 – 1425028

Tower model	Ref. No.	1425022	1425023	1425024	1425025	1425026	1425027	1425028
Guardrail 1.80 m	1205.180	2	2	2	2	2	2	2
Diagonal brace 2.50 m	1208.180	2	2	4	4	6	6	8
Diagonal brace 1.95 m	1208.195	0	2	0	2	0	2	0
Safety double guardrail	1216.180	2	4	4	6	6	8	8
Deck 1.80 m	1241.180	1	2	2	3	3	4	4
Access deck 1.80 m	1242.180	1	2	2	3	3	4	4
Stabiliser, extendible	1248.260	4	4	4	4	4	4	4
Rotation lock for stabiliser	1248.261	4	4	4	4	4	4	4
Spring clip	1250.000	4	4	8	8	12	12	16
Ladder frame 150/4- 1.00 m	1299.004	2	0	2	0	2	0	2
Ladder frame 150/8- 2.00 m	1299.008	2	4	4	6	6	8	8
Uni assembly hook	1300.010	1	1	1	1	1	1	1
Access ledger 0.75 m	1344.003	1	1	1	1	1	1	1
Castor 700	1359.200	4	4	4	4	4	4	4
End toe board	1438.144	2	2	2	2	2	2	2
Toe board with claw	1439.180	2	2	2	2	2	2	2
Ballast	1249.000	For number of ballast weights, see Section 3.3.2: Tower models						

### 3.3.4 ASSEMBLY SEQUENCE SAFETY ASSEMBLY P2 SAFETY<sup>PLUS</sup> WITH DOUBLE GUARDRAIL

Observe the general directions for assembly and use on pages 5 – 7. The assembly examples shown are intended for use up to a maximum platform height of 12 m indoors and up to a maximum platform height of 8 m outdoors. The snap-on claws of the parts should generally be fully engaged. Level the scaffolding structure after basic assembly. This is done using the threaded spindles of the castors.



**The castors must be locked during assembly, modification or dismantling and while there is anybody on the scaffolding structure.**

Hammer home the wedges in the system until the blow bounces off. Always tighten the screw couplers well (50 Nm).

The **item numbers** for the components relate to the component list on pages 55 – 58.

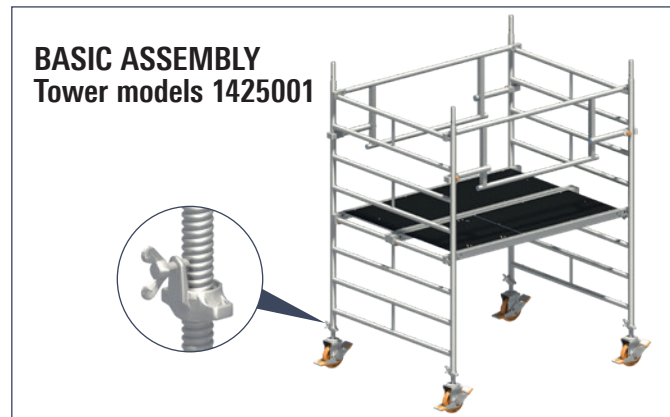

1. Insert the castors **1** in the ladder frames 150/8 **16** and secure them against falling out by tightening the wing screws on the spindle nuts.
2. Position a ladder frame 150/8 **16**, hook two safety double guardrails **20** onto the topmost rung using the snap-on housings at the top handrail and connect to a second ladder frame 150/8 **16** that has previously been positioned on the opposite side at an angle to the outside, again at the topmost rung.

*In each case, make sure that the claws come up against the rung's shift preventer on the inside (bulge on the top side of the rung) in order to allow the lower claws to swivel freely.*

Then swivel the second ladder frame 150/8 **16** inwards at the bottom parallel to the first ladder frame and into position so that the lower guardrail claws can be snapped on at the upright tubes.

3. Hook the deck **29** and access deck **28** into the fourth rung from the bottom of the ladder frames 150/8 **16**.

Further assembly is performed as per page 44, "Assembly of intermediate platforms".

## BASIC ASSEMBLY

Tower models  
1425006 and  
1425008



1. Insert the castors **1** into the mobile beams **8/9** and secure them against falling out by tightening the wing screws on the spindle nuts.
2. The mobile beams **8/9** must be connected with a basic tube **10** – or optionally with a basic strut **11** – and a deck **29**.
3. Fit two ladder frames 150/4 **15** on the mobile beams and secure using spring clips **17**.

Further assembly is performed as per page 44, “Assembly of intermediate platforms”.

## BASIC ASSEMBLY

Tower models  
1425007

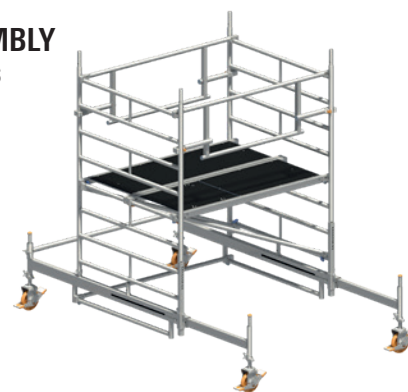

1. Insert the castors **1** into the mobile beams **8/9** and secure them against falling out by tightening the wing screws on the spindle nuts.
2. The mobile beams **8/9** must be connected to one another with a basic tube **10** – or optionally with a basic strut **11** – and a guardrail **18** at the access ledger of the mobile beam.
3. Fit a ladder frame 150/8 **16** on the mobile beam **8/9** and secure it using spring clips **17**. Hook two safety double guardrails **20** onto the topmost rung using the snap-on housings at the top handrail and connect to a second ladder frame 150/8 **16** that has previously been positioned on the opposite side at an angle to the outside, again at the topmost rung.

*In each case, make sure that the claws come up against the rung's shift preventer on the inside (bulge on the top side of the rung) in order to allow the lower claws to swivel freely.*

Then swivel the second ladder frame 150/8 **16** upwards and fit into the spigots of the mobile beam **8/9**

4. Fit two diagonal braces **24**, the deck **29** and the access deck **28**.  
**Make sure that a diagonal brace is installed in the direction of the access hatch. Snap the second diagonal brace on the side of the deck in the same direction but with the snap-on claw snapped into the rungs from below.** The two diagonal braces can also optionally be installed in opposite directions, crosswise (not shown).
5. Move up and onto the next platform up, which is already completely secured by means of two-part side protection. Fix the safety double guardrail **20** by pressing gently towards the outside in order to engage the lower claws in the upright tube of the ladder frames.

Further assembly is performed as per page 44, "Assembly of intermediate platforms".

## BASIC ASSEMBLY

### Tower models

1425002, 1425004,  
1425022, 1425024,  
1425026 and  
1425028



1. Insert the castors **1** in the ladder frames 150/4 **15** and secure them against falling out by tightening the wing screws on the spindle nuts.
2. Mount a ladder frame 150/8 **16** on a ladder frame 150/4 **15** and secure it using spring clips **17**. Hook two safety double guardrails **20** onto the topmost rung using the snap-on housings at the top handrail and connect to a second ladder frame 150/8 **16** that has previously been positioned on the opposite side at an angle to the outside, again at the topmost rung.
3. Fit two diagonal braces **23** crosswise. Assemble two guardrails **18** at the bottom rung of the ladder frame 150/4 **15** and then hook in a deck **29** and an access deck **28**.
4. To maintain the maximum distance from the first rung, fit an access ledger **12** on the ascent side of the rolling tower.
5. Move up and onto the next platform up, which is already completely secured by means of two-part side protection. Fix the safety double guardrail **20** by pressing gently towards the outside in order to engage the lower claws in the upright tube of the ladder frames.

*In each case, make sure that the claws come up against the rung's shift preventer on the inside (bulge on the top side of the rung) in order to allow the lower claws to swivel freely.*

Then swivel the second ladder frame 150/8 **16** upwards and into the spigots of the ladder frame 150/4 **15** and secure using spring clips **17**

Further assembly is performed as per page 44, "Assembly of intermediate platforms". Further assembly for model 1425022 is performed as per page 45 "Completing the working platform".



## BASIC ASSEMBLY

Tower models  
1425023,  
1425025 and  
1425027



1. Insert the castors **1** in the ladder frames 150/8 **16** and secure them against falling out by tightening the wing screws on the spindle nuts.
2. Position a ladder frame 150/8 **16**, hook two safety double guardrails **20** onto the topmost rung using the snap-on housings at the top handrail and connect to a second ladder frame 150/8 **16** that has previously been positioned on the opposite side at an angle to the outside, again at the topmost rung.

*In each case, make sure that the claws come up against the rung's shift preventer on the inside (bulge on the top side of the rung) in order to allow the lower claws to swivel freely.*

Then swivel the second ladder frame 150/8 **16** inwards at the bottom parallel to the first ladder frame and into position so that the lower guardrail claws can be snapped on at the upright tubes.

3. Hook the deck **29** and access deck **28** into the fourth rung from the bottom of the ladder frames 150/8 **16**. Fit two diagonal braces **24**. **Make sure that a diagonal brace is installed in the direction of the access hatch. Snap the second diagonal brace on the side of the deck in the same direction but with the snap-on claw snapped into the rungs from below.** The two diagonal braces can also optionally be installed in opposite directions, crosswise (not shown). Assemble **two guardrails 18** at the bottom rung of the ladder frame 150/8 **16**.
4. To maintain the maximum distance from the first rung, fit an access ledger **12** on the ascent side of the rolling tower.
5. Move up and onto the next platform up, which is already completely secured by means of two-part side protection. Fix the safety double guardrail **20** by pressing gently towards the outside in order to engage the lower claws in the upright tube at the ladder frames.

Further assembly is performed as per page 44, "Assembly of intermediate platforms".

## ASSEMBLY OF INTERMEDIATE PLATFORMS ALL TOWER MODELS WITH SAFETY STRUCTURE P2 SAFETY<sup>PLUS</sup> with double guardrail

**i** Repeat the following assembly steps 1 to 5 several times depending on the assembly height.

1. Mount the first ladder frame 150/8 **16** and secure it using spring clips **17**.

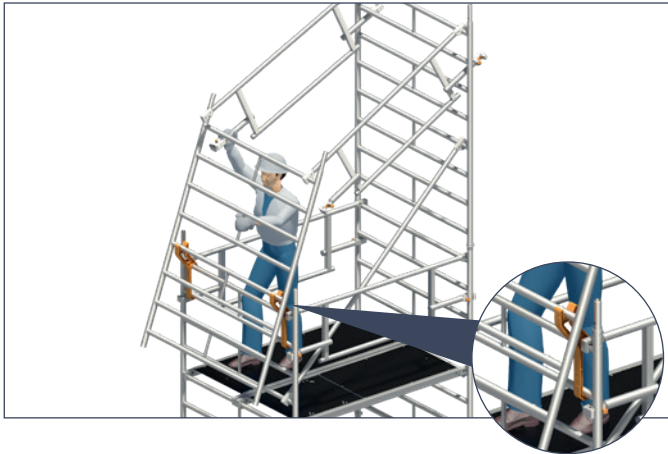

2. Attach the Uni assembly hooks **30** and position the second ladder frame 150/8 **16**. Fit a diagonal brace **23** rising from the ladder frame 150/8 **16** on the side of the Uni assembly hooks **30** to the already fitted ladder frame 150/8 **16**. Hook two safety double guardrails **20** with the snap-on housing at the top handrail in the top rung of the fitted ladder frame 150/8 **16** and connect them to the second ladder frame 150/8 **16**, which was previously positioned in the Uni assembly hook **30**, again at the top rung.

In each case, make sure that the claws come up against the rung's shift preventer on the inside (bulge on the top side of the rung) in order to allow the lower claws to swivel freely.



3. Swivel the ladder frame 150/8 **16** upwards out of its position in the Uni assembly hooks **30**, mount it and secure it using spring clips **17**.

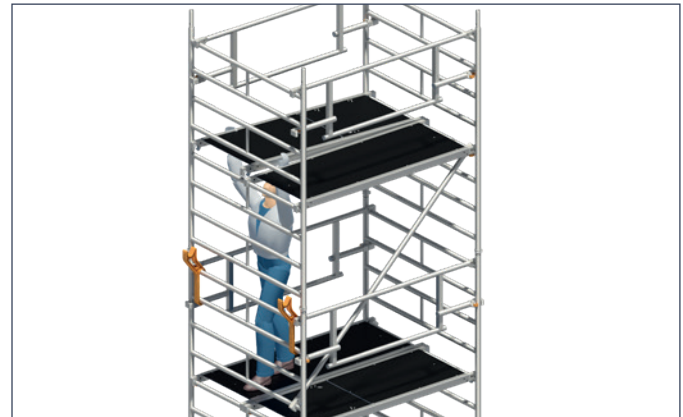

4. Insert the second diagonal brace **23**, the deck **29** and the access deck **28**.

*Make sure that the diagonal braces **23** cross over one another and ascend as a tower-like structure (in a zig-zag) on both sides.*



5. Move up and onto the next platform up, which is already completely secured by means of two-part side protection. Fix the safety double guardrails **20** by pressing gently towards the outside in order to engage the lower claws in the upright tube at the ladder frames.

## COMPLETING THE WORKING PLATFORM

All tower models for creating the required working platform

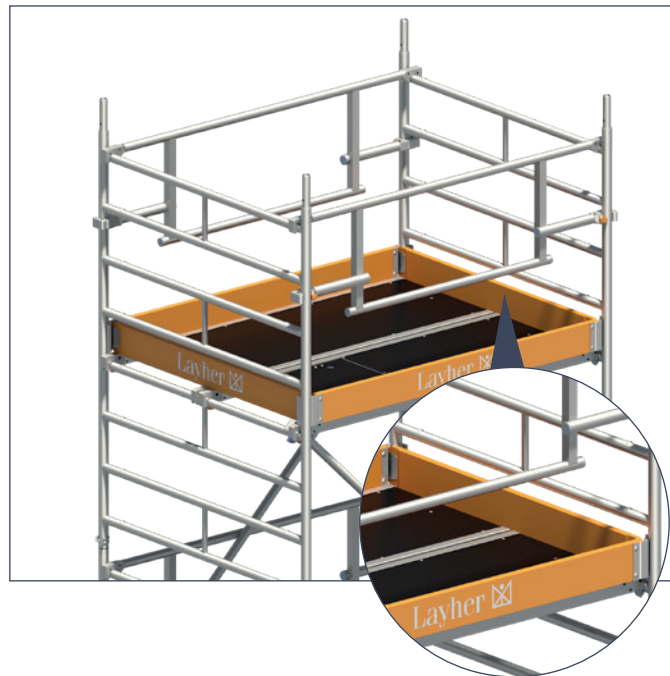

To complete the working platform, attach toe boards with claw **31** and end toe boards 150 **32**.



If an intermediate platform is used as a working platform, it is also necessary to attach toe boards here.

### 3.3.5 DISMANTLING SEQUENCE SAFETY STRUCTURE P2 SAFETY<sup>PLUS</sup> WITH DOUBLE GUARDRAIL

 Repeat the following dismantling steps 1 to 6 several times depending on the assembly height.

Dismantling is performed in the reverse order to assembly.

When dismantling, do not remove the bracing elements such as diagonal braces, guardrails, **decks or access decks until the ladder frames above them have been dismantled.**

To lift out the individual parts, open the snap-on claws by pressing their locking clips.

1. Dismantle the toe boards **31/32** (only necessary on the working platform).
2. Before coming down, make sure that the fastening of the safety double guardrail **20** has been undone by releasing the lower claws at the upright tube of the ladder frame 150/8 **16**. This is easier if you lift it slightly when unlocking it. After releasing the fastening, position each of the safety double guardrails **20** with the upper claws inside at the rung's shift preventer (bulge at the top of the rung) again in order to allow the lower claws to swivel freely.



3. After climbing down to the platform below, attach the Uni assembly hooks **30** and you can remove the spring clips **17** above.
4. Dismantle the deck **29**, the access deck **28** and the diagonal brace **23** that climbs upwards in the direction of the previously mounted Uni assembly hooks **30**.



5. Lift out the ladder frame 150/8 **16** on the Uni assembly hook side and swivel it downwards together with the two safety double guardrails **20** and then position it in the Uni assembly hooks **30**.



6. Lift the two safety double guardrails **20** out of the ladder frame **150/8 16** positioned in the Uni assembly hooks **30** and place down suspended on one side at the ladder frame **150/8 16** opposite. Secure the ladder frame positioned in the Uni assembly hooks **30** against falling or tipping and then remove the safety double guardrail **20** from its suspended position. Dismantle the second diagonal brace **23** so that the ladder frame **150/8 16** that is still mounted can be removed.



## 4. CASTORS AND MOBILE BEAMS

### OPERATING THE CASTOR



During assembly and while working, lock the castors by pressing down the brake lever labelled STOP. When the brake is locked, the lever labelled STOP must be in the down position. To move the structure, unlock the castors by pressing the opposite lever.

### ADJUSTING THE MOBILE BEAM

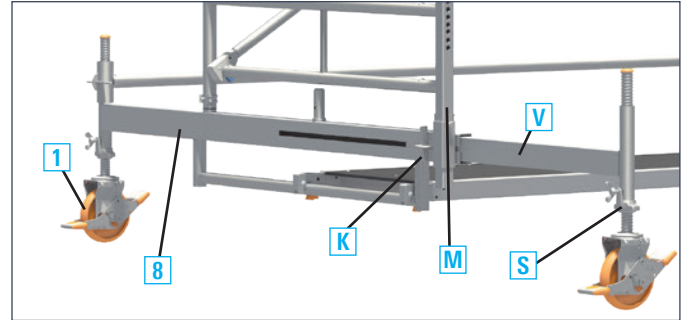

The adjustable mobile beam **8/9** makes it possible to work in a central position and at the wall without dismantling the tower. It can be pushed in and out in the assembled state. It must be ensured that before any movement the ballast weights specified in the ballasting table are attached at the right place (see respective "Tower models" section). For adjustment in the assembled state, lower the central support **M** attached to the mobile beam **8/9** as far as possible and secure it. Take the load off the castors **1** at the sliding parts by turning the spindles **S** far enough for the adjusting part **V** to be adjusted after releasing the clamping wedge **K**. After adjustment, fix the clamping wedge **K** in place, put the load back onto the castor **1** by extending the spindle, and then raise and secure the central support **M**.



## MAXIMUM SPINDLE EXTENSION OF THE DIFFERENT TOWER MODELS

### Assembly with 1323.320

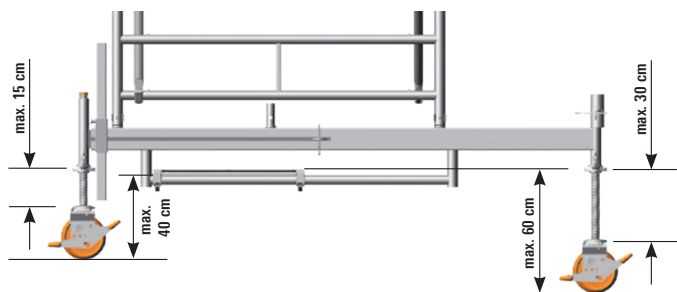

### Assembly directly on castors with access ledger

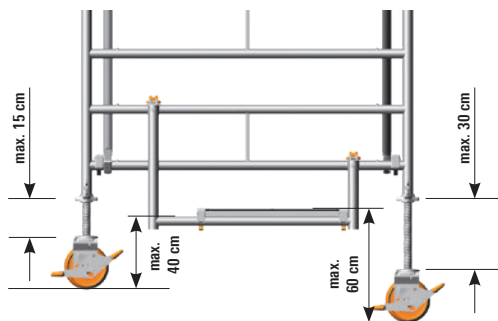

### Assembly directly on castors

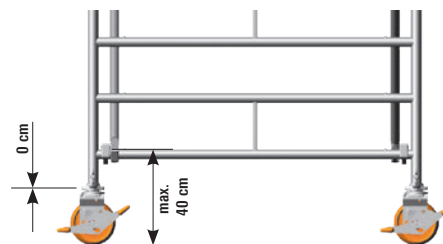

## 5. BALLASTING

### Attachment of ballast weights

**i** Ballasting does not depend on the assembly variant, and applies for the tower models stated in each case. The figures are shown by way of example and refer to Safety Structure P2.

#### Assembly, central:

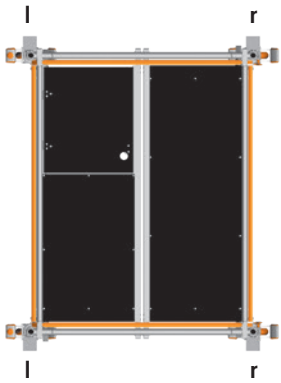

Models:  
1405001 – 1405005  
1415002 – 1415005  
1425001 – 1425005

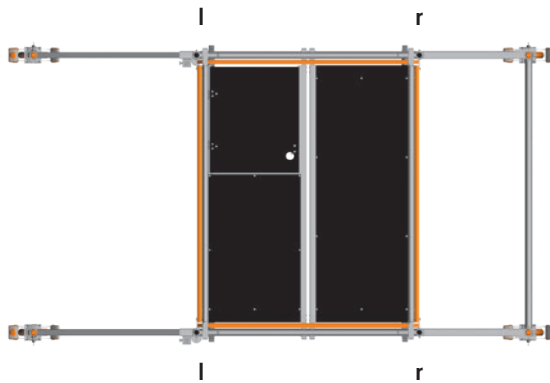

Models:  
1405006 – 1405008  
1415006 – 1415008  
1425006 – 1425008

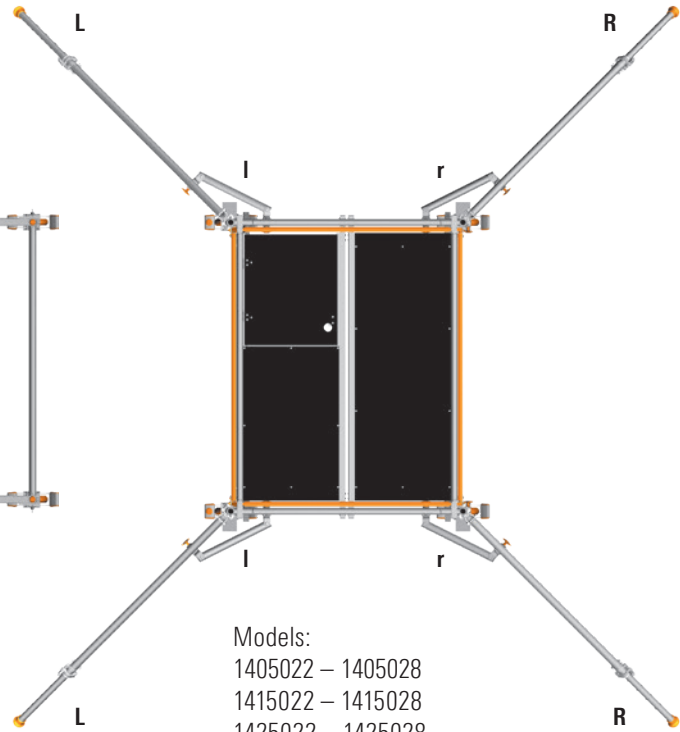

Models:  
1405022 – 1405028  
1415022 – 1415028  
1425022 – 1425028

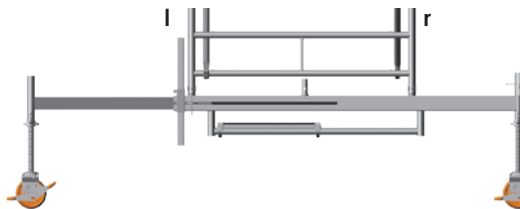



When attaching large numbers of the ballast weights required in any given case, it is possible that additional tubular components with a tube diameter of 48.3 mm may be needed as extensions at or in close proximity to the fixing points. These components (e.g. Uni distance tube, couplers, basic strut or basic tube) are not counted in the number of ballast weights in the model description or the parts lists and must be taken into account for the respective model and associated assembly site and be included as part of the assembly.

### Assembly, off-centre:

For the off-centre assembly variant with wall bracing the bracing must always be attached on the side "L".

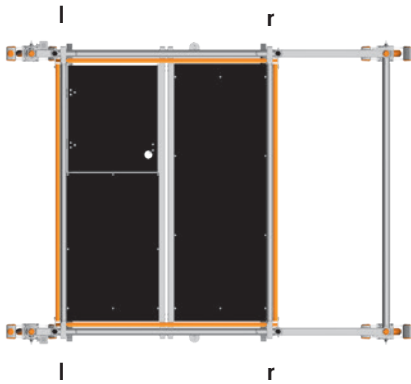

Models:  
1405006 – 1405008  
1415006 – 1415008  
1425006 – 1425008

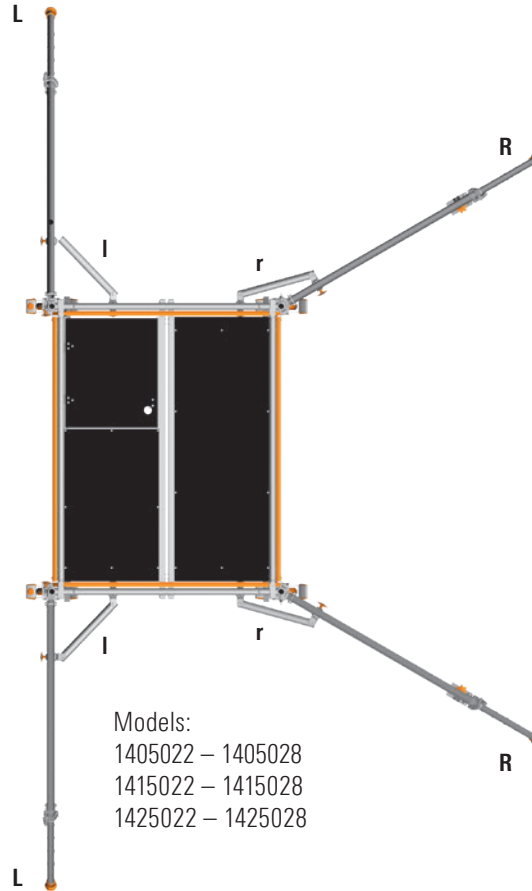

Models:  
1405022 – 1405028  
1415022 – 1415028  
1425022 – 1425028

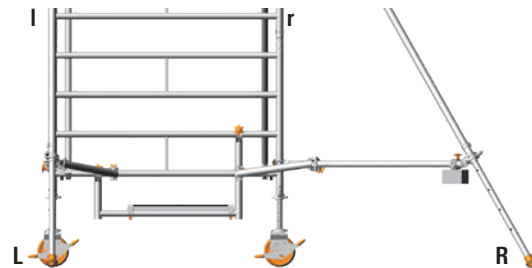
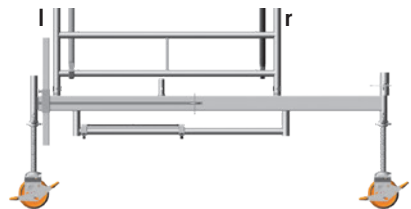

## Example for assembly of model 1405004

### Assembly, indoors in central position

Ballast: see respective section on "Tower models"



Tower model	1405004
Working height [m]	6.20
Tower height [m]	5.43
Platform height [m]	4.20
Weight [kg] (without ballast)	224.0
Ballasting	
Indoors	
Assembly, central	14 r4
Assembly, off-centre	X
Assembly, off-centre with wall bracing	14 r0
Outdoors	
Assembly, central	17 r7
Assembly, off-centre	X
Assembly, off-centre with wall bracing	110 r4

 The ballasting is independent of the assembly variant. The figure is shown by way of example and refers to Safety Structure P2.

## 6. ATTACHING THE STABILISERS

Before attaching the stabilisers, the basic assembly procedure for rolling tower models without mobile beam must be followed. Instead of mobile beams, extendable stabilisers or 5-metre stabilisers are used.



Ballasting does not depend on the assembly variant. The figures are shown by way of example and refer to Safety Structure P2.

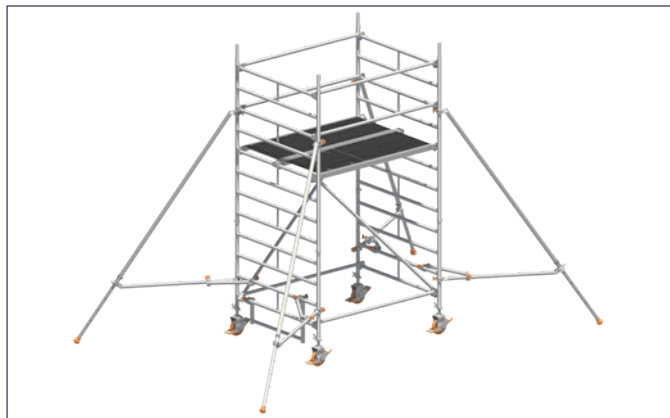

Attach a stabiliser **33** to each stile of the ladder frame **15/16** as follows: Position the top half-coupler of the stabiliser **33** at the appropriate height on the ladder frame **15/16**. Before definitively tightening the handwheels, use the half-couplers to also position the transverse tube at the appropriate height at the ladder frame **15/16**. After alignment of the stabilisers in the correct position (against wall or free-standing) and ensuring a firm stand on the ground, tighten the half-couplers using the handwheels. Make sure that the spring clips safely engage in the telescoping parts of the extendable stabiliser.

Set the alignment of the stabilisers as follows:

### Free-standing assembly:

in each case about 60° to the tower longitudinal side (Fig. left).

### Assembly against a wall

On the wall side about 90° to the tower end face

Side facing away from the wall about 60° to the tower longitudinal side (Fig. right).

The specified angles can be checked after attachment of the stabilisers **33** on the basis of the length dimensions "Spacing L". To ensure that the position of the stabilisers cannot change, for example due to inadvertent rotation, attach the tower rotation lock **34** to the stabiliser **33**. Position the tower rotation lock **34** between the ladder frame **15/16** and the stabiliser **33** such that one half-coupler is fastened to the transverse tube of the stabiliser and the second half-coupler to the ladder frame rung. After positioning, tighten the half-couplers using the handwheels. When moving the Mobile Working Platform, do not lift the stabiliser **33** more than 2 cm off the ground. Correct ballasting of the individual models is specified in the table for ballasting (see respective section "Tower models"). For work performed on a load-bearing wall, wall bracing can be fitted on both sides of the tower, allowing a reduction of the ballasting in accordance with the figures in the ballasting table (see appropriate section "Tower models").

### Free-standing assembly

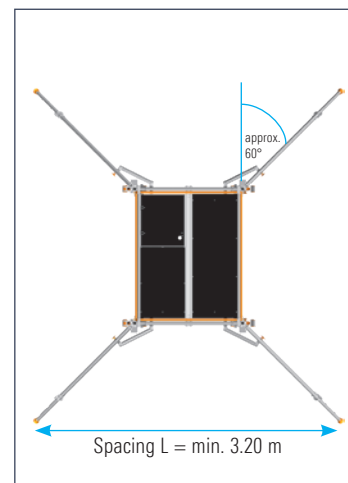

### Assembly against a wall

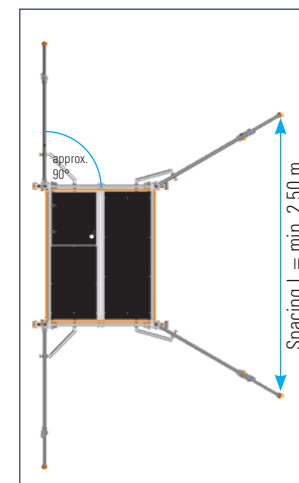

## 7. WALL BRACING (under compression) ANCHORING (under compression and tension)



For work performed on a load-bearing wall, you can reduce the ballasting in accordance with the **Ballasting** table (see the corresponding "Tower models" section). In this case, wall bracing or anchoring must be installed on both sides of the tower. Use the Uni distance tube **26** and fix it to the ladder frame **15/16** using two couplers **27** in each case. Position the rubber mount at the wall (see detail A) to provide support. The Uni distance tube **26**, rotated by 180°, is used for anchoring and is fitted in an eyebolt which was attached to the wall previously (see detail B). The mobile beams must be installed so that they project from the side facing away from the wall. Attach the wall bracing / anchoring at the height of the top working platform or at most 1 m below that.

**i** Wall bracing / anchoring does not depend on the assembly variant. The figures are shown by way of example and refer to Safety Structure P2.

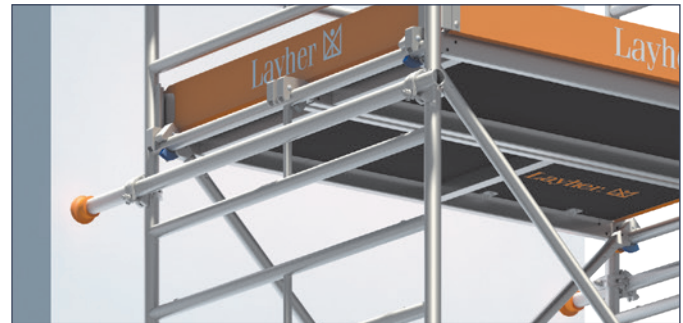

Detail A



Detail B



## 8. COMPONENTS OF THE SYSTEM

1



### 1359.200 Castor 700

Plastic wheel, D=200 mm. With base plate, adjustment range 0.30 – 0.60 m, spindle nut with lock, wheel with twin brake lever and load centring when braked, permissible load: 7.0 kN ( $\approx$  700 kg)

*Functioning predecessor article 1259.200 / 1259.201 (not shown) can remain in use.*

2



### 1358.200 Castor 700 with polyurethane tyre

Plastic wheel, D=200 mm. With base plate, adjustment range 0.30 – 0.60 m, spindle nut with lock, wheel with twin brake lever and load centring when braked, permissible load: 7.0 kN ( $\approx$  700 kg)

*Functioning predecessor article 1268.200 / 1259.201 (not shown) can remain in use.*

3



### 1260.201 Castor 1000

Plastic wheel, D=200 mm of polyamide. With base plate, adjustment range 0.30 – 0.60 m, spindle nut with lock, wheel with twin brake lever and load centring when braked, permissible load: 10 kN ( $\approx$  1,000 kg)

*Functioning predecessor article 1260.200 (not shown) can remain in use.*

4



### 1260.202 Castor 1000 with electrically conductive polyurethane tyre

Plastic wheel, D=200 mm, made of polyamide with tyre of electrically conductive polyurethane. With base plate, adjustment range 0.30 – 0.60 m, spindle nut with lock, wheel with twin brake lever and load centring when braked. Permissible load 10 kN ( $\approx$  1,000 kg). Special wheel for sensitive floors and, thanks to electrical conductivity, usable in explosion-proof or in ESD-risk areas, electrical leakage resistance as per DIN EN 12526  $< 10^4 \Omega$ .

5



### 1300.150 Castor, D=150 mm with baseplate 250

Plastic wheel, with base plate, adjustment range 0.2 – 0.35 m, spindle nut with lock, wheel with twin brake lever and load centring when braked, permissible load capacity: 7 kN ( $\approx$  700 kg)

6



### 1301.150 Castor 400, D=150 mm

Plastic wheel, with twin brake lever, permissible load: 4 kN ( $\approx$  400 kg)

*Functioning predecessor article 1308.150 (not shown) can remain in use.*

7



### 1303.150 Castor 400, D=150 mm with polyurethane tyre

Plastic wheel with polyurethane tyre, special wheel for sensitive floors, permissible load: 4 kN ( $\approx$  400 kg)

*Functioning predecessor article 1309.150 (not shown) can remain in use.*



8

**1323.320 Mobile beam with access ledger, adjustable**

Steel rectangular tube, hot-dip-galvanised, system part for base widening



9

**1338.320 Mobile beam with 2 spigots, adjustable**

Steel rectangular tube, hot-dip-galvanised. For base widening in special rolling tower structures. System structures only possible in combination with Ref. No. 1337.000



10

**1211.180 Basic tube**

Steel tube, hot-dip-galvanised



11

**1324.180 Basic strut**

with 2 half-couplers, steel tube hot-dip-galvanised



12

**1344.003 Access ledger**

Aluminium



13

**1249.000 Ballast (10 kg)**

Steel, hot-dip-galvanised with half-coupler



14

**1337.000 Spigot, adjustable**

Steel, hot-dip-galvanised. For system structures in combination with Ref. No. 1338.320

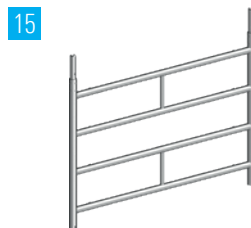

15

**1299.004 Ladder frame**

Aluminium, rungs with non-slip grooving

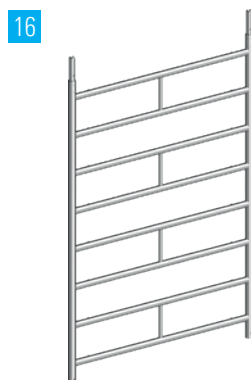

16

**1299.008 Ladder frame**

Aluminium, rungs with non-slip grooving



17

**1250.000 Spring clip**

Steel

18



**1205.180 Guardrail**  
Aluminium

19



**1206.180 Double guardrail**  
Aluminium

20



**1216.180 Safety double guardrail**  
Double guardrail 1.80 m,  
aluminium

21



**1204.180 Uni telescoping guardrail**  
1.80 m + 2.85 m

22

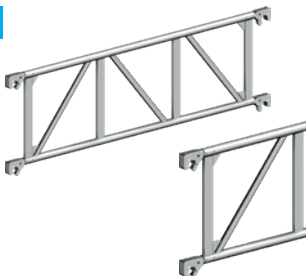

**1207.180 Beam**  
Aluminium for use as support element in scaffolding construction kit or as double side protection.

23



**1208.180 Diagonal brace**  
Aluminium

24



**1208.195 Diagonal brace**  
Aluminium

25

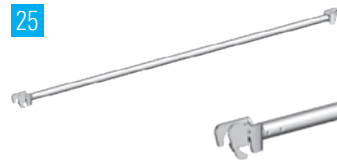

**1347.250 Deck diagonal brace**  
Aluminium

26



**1275.180 Uni distance tube**  
Aluminium tube with hook and rubber mount.

27



**4700.019 / 4700.022 Double coupler**  
Steel, galvanised

28

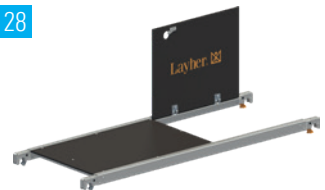

**1242.180 Access deck**  
Aluminium frame, with plywood deck and hatch with phenolic resin coating

29

**1241.180 Deck**

Aluminium frame, with plywood deck with phenolic resin coating

30

**1300.010 Uni assembly hook**

Pair

31

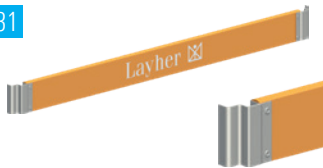
**1439.180 Toe board with claw**

Wood

32

**1438.144 End toe board**

Wood

33

**1248.260 Stabiliser, extendible**

Aluminium

34

**1248.261 Rotation lock for stabiliser**

35

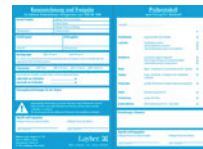
**6344.400 Tower identification block**

Block consisting of 50 units.

36

**6344.011 See-through pocket**

for Ref. No. 6344.400, 10 items with integr. prohibition sign

## 9. CERTIFICATE

In order to ensure up-to-date documentation, you can obtain the appropriate certificate on request using the contact details stated overleaf.



The currently available certificate applies to the assembly form **3.1 Rolling towers with Safety Structure P2**. Assembly forms **3.2 Rolling towers with Safety Structure P2 with Uni telescoping guardrail** and **3.3 Rolling towers with Safety Structure P2 SAFETY<sup>PLUS</sup>** are currently undergoing certification and the corresponding certificates will be made available as soon as they have been issued.



**Layher**® 

More Possibilities. The Scaffolding System.

**Wilhelm Layher GmbH & Co KG**  
Scaffolding Grandstands Ladders

Ochsenbacher Strasse 56  
74363 Gueglingen-Eibensbach  
Germany

P.O. Box 40  
74361 Gueglingen-Eibensbach  
Germany  
Phone +49 (0)7135 70-0  
Fax +49 (0)7135 70-265  
E-mail [info@layher.com](mailto:info@layher.com)  
[www.layher.com](http://www.layher.com)