

## Layher Uni Standard Tower Instructions for Assembly and Use

**Mobile working platforms**  
to DIN EN 1004 : 2005-03

Working platform 0.75 x 2.85 m

max. working height:  
indoors 13.6 m  
outdoors 9.6 m

Load bearing capacity 2.0 kN/m<sup>2</sup>  
on max. one working level  
(scaffold group 3 to DIN EN 1004 : 2005-03)



Layher® 

More Possibilities. The Scaffolding System.



# Tower Types

## Layher Uni Standard Tower

For **outdoor use** observe height limits.

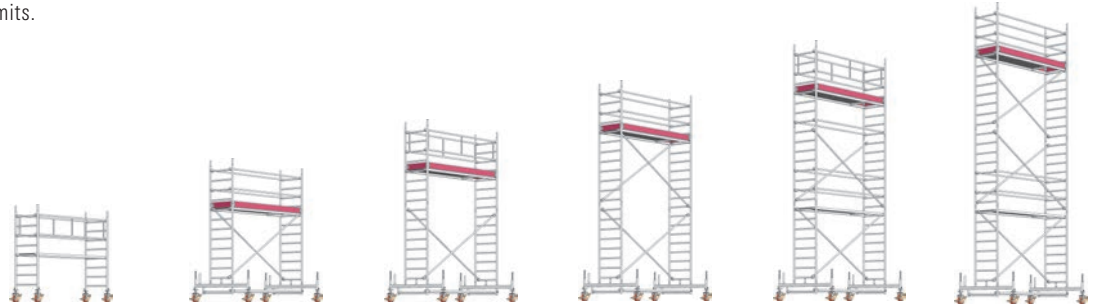
### Tower Models 1101 – 1106





Tower Model	1101	1102	1103	1104	1105	1106
Working height (m) → 	3.5	4.5	5.5	6.5	7.5	8.5
Scaffold height <sup>1)</sup> (m) → 	2.6 (2.45)	3.75 (3.60)	4.75 (4.60)	5.75 (5.60)	6.75 (6.60)	7.75 (7.60)
Platform height (m) → 	1.5	2.5	3.5	4.5	5.5	6.5
Weight (kg) [without ballast]	86.0	163.9	173.3	189.7	242.3	251.5

<sup>1)</sup> Values in brackets: minimum tower height incl. spigots.

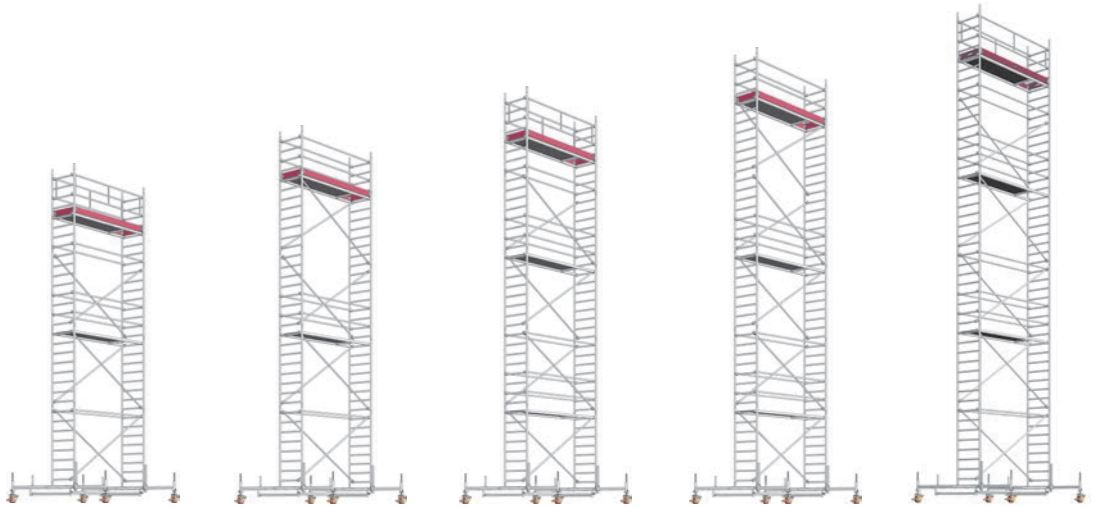
### Tower Models 1107 – 1111



Tower Model	1107	1108	1109	1110	1111
Working height (m) → 	9.6	10.6	11.6	12.6	13.6
Scaffold height <sup>1)</sup> (m) → 	8.79 (8.64)	9.79 (9.64)	10.79 (10.64)	11.79 (11.64)	12.79 (12.64)
Platform height (m) → 	7.6	8.6	9.6	10.6	11.6
Weight (kg) [without ballast]	326.5	335.7	388.3	397.5	421.3

<sup>1)</sup> Values in brackets: minimum tower height incl. spigots.



# Tower models with stabilizers, extendable

Layher Uni Standard Tower

For **outdoor use** observe height limits.

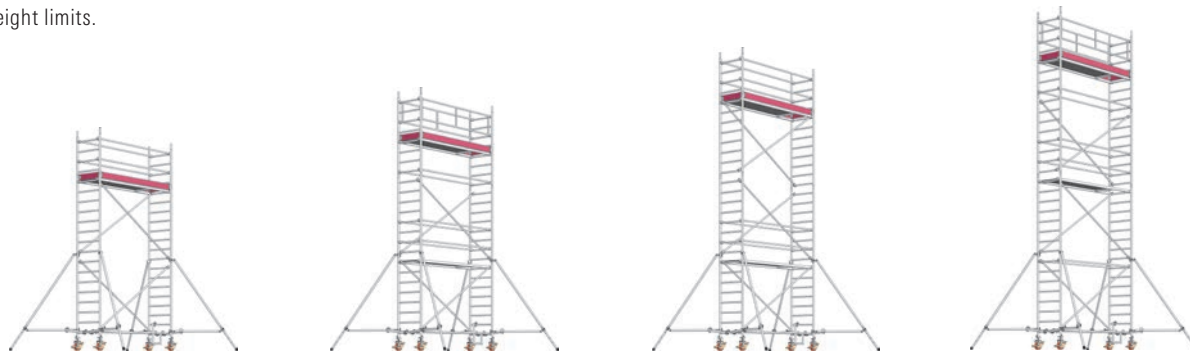
## Tower Models 1124 – 1127





Tower Model	1124	1125	1126	1127
Working height (m) → 	6.5	7.5	8.5	9.5
Scaffold height <sup>1)</sup> (m) → 	5.7 (5.45)	6.7 (6.45)	7.7 (7.45)	8.7 (8.45)
Platform height (m) → 	4.5	5.5	6.5	7.5
Weight (kg) [without ballast]	198.3	250.9	260.1	283.9

<sup>1)</sup> Values in brackets: minimum tower height incl. spigots.

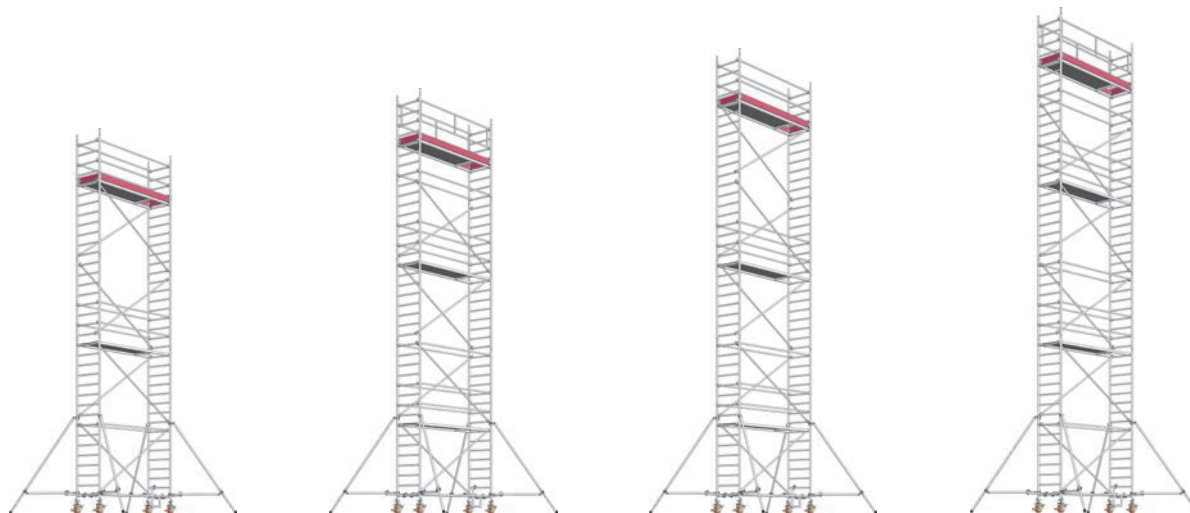
## Tower Models 1128 – 1131



Tower Model	1128	1129	1130	1131
Working height (m) → 	10.5	11.5	12.5	13.5
Scaffold height <sup>1)</sup> (m) → 	9.7 (9.45)	10.7 (10.45)	11.7 (11.45)	12.7 (12.45)
Platform height (m) → 	8.5	9.5	10.5	11.5
Weight (kg) [without ballast]	293.1	345.7	354.9	378.7

<sup>1)</sup> Values in brackets: minimum tower height incl. spigots.



# Tower models with stabilizers, 5 m

Layher Uni Standard Tower

For **outdoor use** observe height limits.

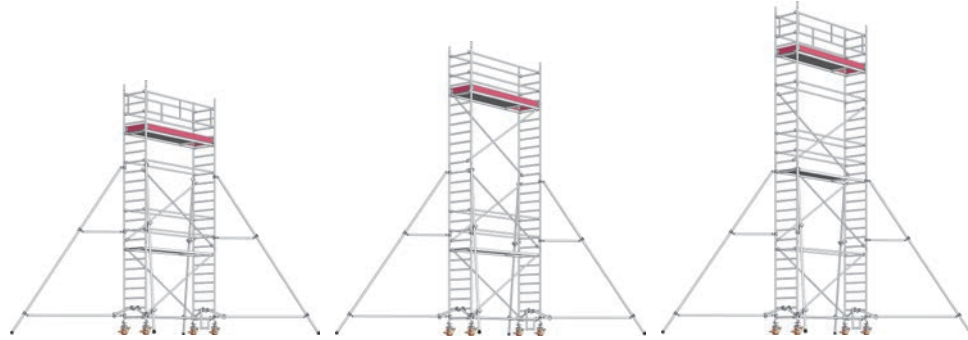
## Tower Models 1145 – 1147





Tower Model	1145	1146	1147
Working height (m) → 	7.5	8.5	9.5
Scaffold height <sup>1)</sup> (m) → 	6.7 (6.45)	7.7 (7.45)	8.7 (8.45)
Platform height (m) → 	5.5	6.5	7.5
Weight (kg) [without ballast]	276.1	284.9	309.1

<sup>1)</sup> Values in brackets: minimum tower height incl. spigots.

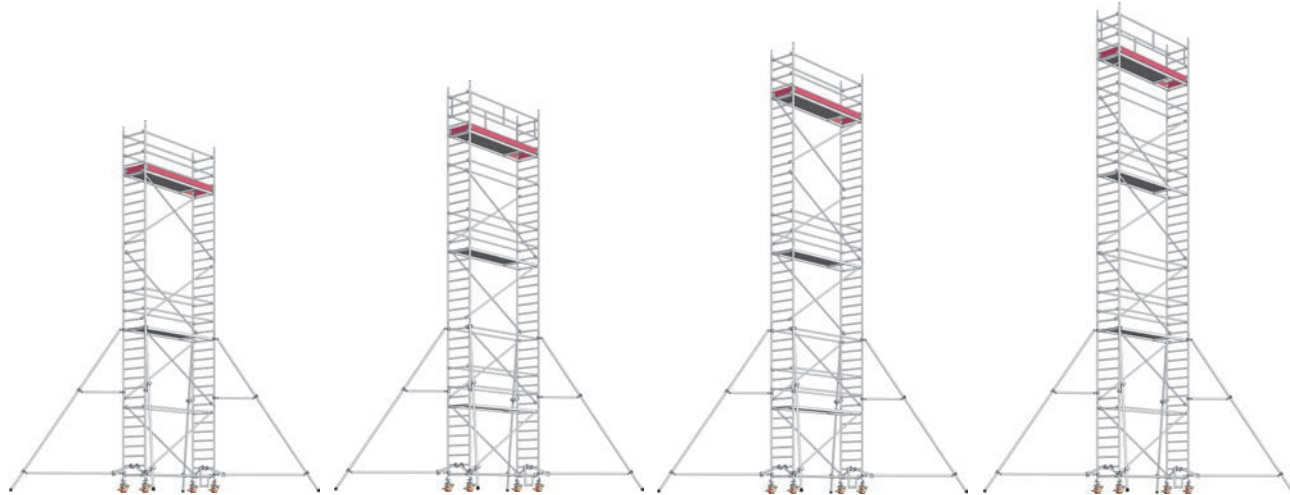
## Tower Models 1148 – 1151



Tower Model	1148	1149	1150	1151
Working height (m) → 	10.5	11.5	12.5	13.5
Scaffold height <sup>1)</sup> (m) → 	9.7 (9.45)	10.7 (10.45)	11.7 (11.45)	12.7 (12.45)
Platform height (m) → 	8.5	9.5	10.5	11.5
Weight (kg) [without ballast]	317.9	370.9	379.7	403.9

<sup>1)</sup> Values in brackets: minimum tower height incl. spigots.

# Tower Types

## Layher Uni Standard Tower

For **outdoor use** observe height limits.

### Tower Models 1201 – 1206

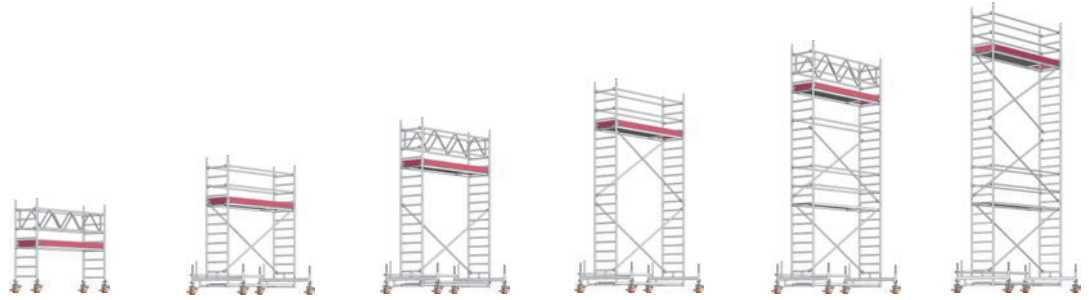

Tower Model	1201	1202	1203	1204	1205	1206
Working height (m) → 	3.5	4.6	5.6	6.6	7.6	8.6
Scaffold height <sup>1)</sup> (m) →	2.70 (2.45)	3.85 (3.60)	4.85 (4.60)	5.85 (5.60)	6.85 (6.60)	7.85 (7.60)
Platform height (m) →	1.5	2.6	3.6	4.6	5.6	6.6
Weight (kg) [without ballast]	102.0	183.2	195.8	209.0	264.8	270.8

<sup>1)</sup> Values in brackets: minimum tower height incl. spigots.

### Tower Models 1207 – 1211

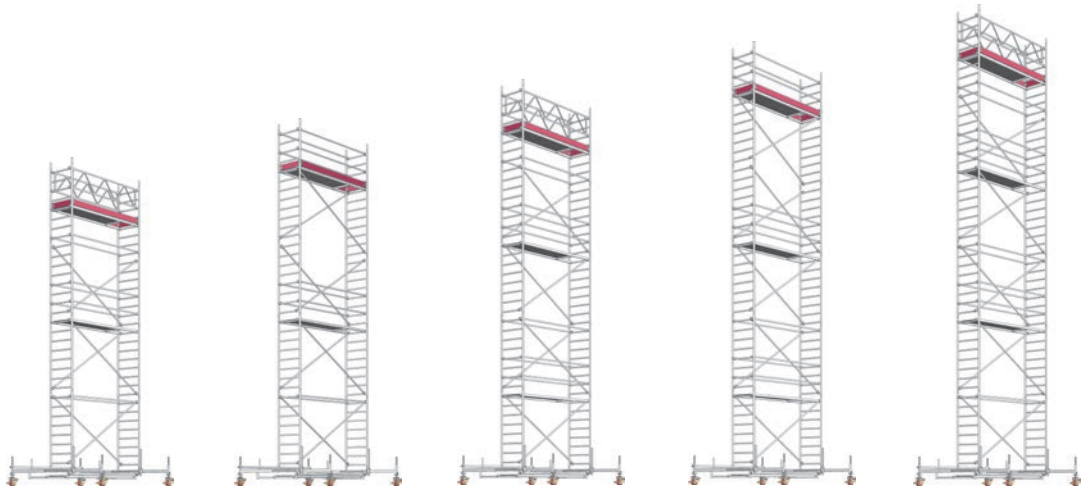

Tower Model	1207	1208	1209	1210	1211
Working height (m) → 	9.7	10.7	11.7	12.7	13.7
Scaffold height <sup>1)</sup> (m) →	8.89 (8.64)	9.89 (9.64)	10.89 (10.64)	11.89 (11.64)	12.89 (12.64)
Platform height (m) →	7.7	8.7	9.7	10.7	11.7
Weight (kg) [without ballast]	364.7	370.7	426.5	432.5	459.5

<sup>1)</sup> Values in brackets: minimum tower height incl. spigots.

# Assembly

►1 Pay attention to the General Assembly and Use Instructions on page 24. The examples shown of the tower types 1108 – 1111, 1128 – 1131, 1208 – 1211 are designed for use indoors. According to the regulations in force since January 1st 1987, the permissible **maximum platform height outdoors is 8 m**. Pay attention to the parts list and ballasting tables on pages 11–13.

## ►2 Basic assembly

### ►2.1 Tower Model 1101

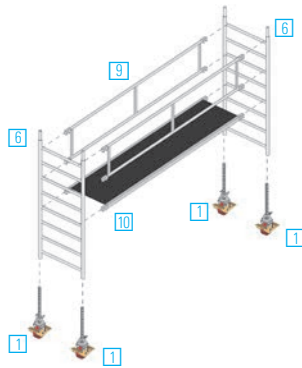

1. The castors **1** of the tower type 1101 are inserted into the ladder frame **6** and secured against falling out by fastening the wing screws on the spindle nuts.

2. Connect both ladder frames **6** with 2 Double guardrails **9**. Clip the access deck **10** onto the 4th ladder **6** rung from the bottom. The snap-on claws of all parts are to be locked onto the ladder rungs from above.

3. A three-part side guard must be provided if required by the valid provisions applying for the work to be performed.

**In order to remove the different parts, depress the locking clips of the snap-on claws. The red claws on the deck enable a single person to assemble or dismantle them easily; open them at one end and rest the base of the clips on the rung. Now open the opposite clips and remove the deck.**

Level the tower using the threaded spindles.

### ►2.2 Tower Models 1102 – 1106

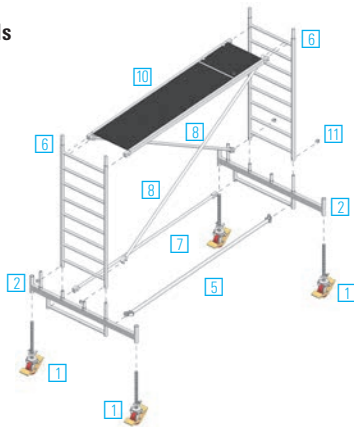

1. Insert the castors **1** into the mobile beam **2** and secure against falling out by fastening the wing screws on the spindle nuts.

2. Connect the mobile beams **2** using a base strut **5** and a guardrail **7**.

3. Mount the two ladder frames **6** and secure with spring clips **11**.

4. **Mount both diagonal braces **8** to the inside of the deck claws and push them outwards as far as possible in order to brace the ladder frames **6**.**

5. For tower models 1102, 1105 and 1106 only, an access deck **10** has to be placed on the eighth rung of the ladder frame **6**.

6. Level the tower using the threaded spindles.

For the following assembly steps, tower types 1102 and 1103 see chapter 5; for tower models 1104–1106 see chapter 4.

### ►2.3 Tower Models 1107 – 1111, 1115, 1116

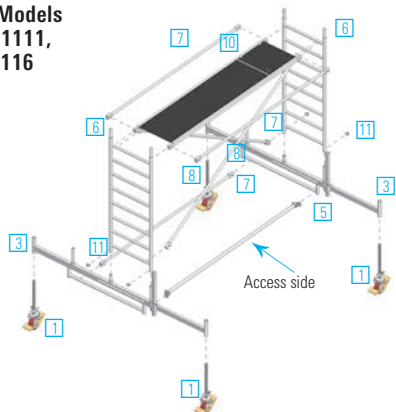

Tower types 1115 and 1116 with adjustable mobile beam **3** are intended for **outdoor use**.

1. Insert the castors **1** into the adjustable mobile beam **3** and secure them against falling out by fastening the wing screws on the spindle nuts.

2. Fix the base strut **5** to the deck supports of the adjustable mobile beam **3** and mount the guardrail **7** onto the deck supports.

3. Add two ladder frames **6** and secure with spring clips **11**.

4. **Mount both diagonal braces **8** inside the deck claws and push them outwards as far as possible in order to brace the ladder frames **6**.**

5. For tower types 1115, 1116, 1109 and 1110, install an access deck **10** on the 8th rung of the ladder frame **6**.

6. On tower types 1107, 1108 and 1111 mount two guardrails **7** on the 8th rung. No access deck **10** is necessary.

7. The horizontal gap between two decks or between decks and ledgers must not exceed 25 mm.

8. Level the tower using the threaded spindles.

For the following assembly steps see chapter 4.

# Assembly

## Layher Uni Standard Tower

### ►3 Basic assembly

#### ►3.1 Tower Model 1201

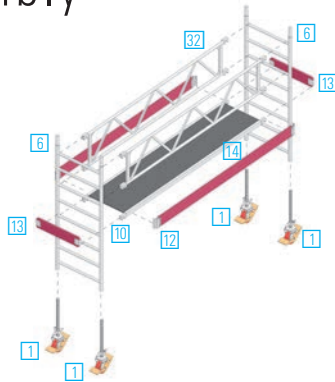

1. The castors **1** of the tower type 1201 are inserted into the ladder frame **6** and secured against falling out by fastening the wing screws on the spindle nuts.

2. Connect both ladder frames **6** with 2 Uni-girders **9**. Clip the access deck **10** onto the 4th ladder **6** rung from the bottom. The snap-on claws of all parts are to be locked onto the ladder rungs from above.

3. Mount the toe boards 2.85 m **12** onto the ladder frames **6** and secure them by fitting the end toe boards **13**.

**In order to remove the different parts, depress the locking clips of the snap-on claws. The red claws on the deck enable a single person to assemble or dismantle them easily; open them at one end and rest the base of the clips on the rung. Now open the opposite clips and remove the deck.**

Level the tower using the threaded spindles.

#### ►3.2 Tower Models 1202 – 1206

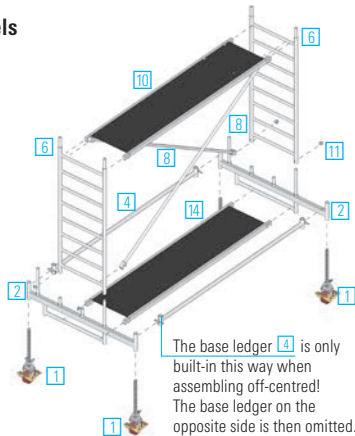

1. Insert the castors **1** into the mobile beam **2** and secure against falling out by fastening the wing screws on the spindle nuts.

2. Connect the mobile beam **2** with the base ledger **4** pinning it onto the protruding stub at the end of the mobile beam **2** and drive in the wedge after alignment. When assembling in an off-centred position, the base ledger will be fixed and wedged at the opposite side of the mobile beam **2**. Insert the deck **14** into the deck support of the mobile beam **2**.

3. Mount the two ladder frames **6** and secure with spring clips **11**.

**4. Mount both diagonal braces **8** to the inside of the deck claws and push them outwards as far as possible in order to brace the ladder frames **6**.**

5. For tower models 1202, 1205 and 1206 only, an access deck **10** has to be placed on the eighth rung of the ladder frame **10**.

6. Take care that the deck **14** is positioned centrally under the ladder frames **6**. Level the tower using the threaded spindles.

For the following assembly steps, tower types 1202 and 1203 see chapter 5; for tower models 1204–1206 see chapter 4.

#### ►3.3 Tower Models 1207 – 1211, 1215, 1216

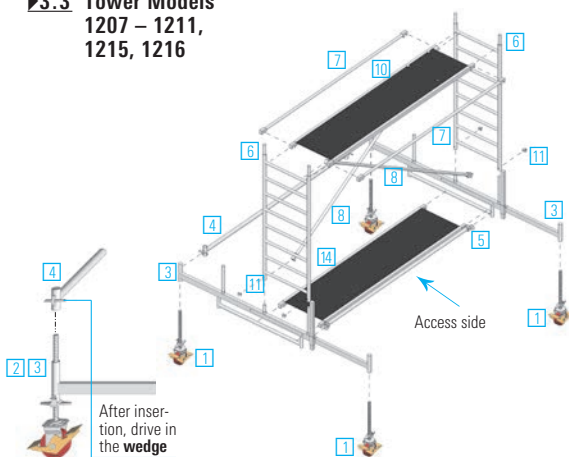

Tower types 1215 and 1216 with adjustable mobile beam **3** are intended for **outdoor use**.

1. Insert the castors **1** into the adjustable mobile beam **3** and secure them against falling out by fastening the wing screws on the spindle nuts.

2. Fix the base strut **5** to the deck supports of the adjustable mobile beam **3** and mount the deck **14** onto the deck supports.

3. Connect the mobile beam **3** with the base ledger **4**, fitting the base ledger **4** over the protruding stub at the end of the adjustable mobile beam **3**. After alignment drive in the wedge.

4. Add two ladder frames **6** and secure with spring clips **11**.

**5. Mount both diagonal braces **8** inside the deck claws and push them outwards as far as possible in order to brace the ladder frames **6**.**

6. For tower types 1215, 1216, 1209 and 1210, install an access deck **10** on the 8th rung of the ladder frame **6**.

7. On tower types 1207, 1208 and 1211 mount two guardrails **7** on the 8th rung. No access deck **10** is necessary.

8. The horizontal gap between two decks or between decks and ledgers must not exceed 25 mm.

9. Take care that the deck **14** is positioned centrally under the ladder frames **6**. Level the tower using the threaded spindles.

For the following assembly steps see chapter 4.

# Assembly

## Layher Uni Standard Tower

### ►4 Assembling the intermediate platform

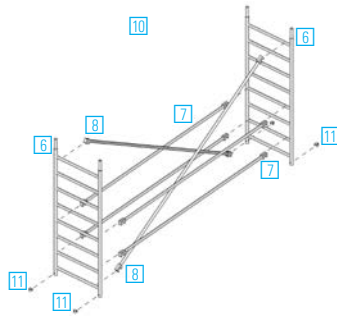

1. During assembly and dismantling, system decks or scaffold planks acc. to DIN 4420 (minimum 28 x 4.5 x 350 cm long) must be used as auxiliary decks at maximum height intervals of 2.0 m. These auxiliary decks, providing a safe footing for assembly and dismantling, are removed after the erection. Each platform must be completely boarded.

2. Continue assembly by adding ladder frames [6] bracing them with guardrails [7] and diagonal braces [8] in accordance with the examples. Secure the joints of the ladder frames [6] with spring clips [11].

3. Access decks [10] are to be built in at maximum height intervals of 4 m. If these access decks serve as intermediate platforms for ascending, two guardrails [7] at each side are required only.

When they are used as a working platform, double guardrails and toe boards (see chapter 4) are to be built in. In this case the top or any other working level must not be used. The toe boards there should be removed.

**After assembly the guardrails [7] and diagonal braces [8] should be pushed outwards as far as possible.**

4. When assembling the towers, care is needed to ensure the correct order of the diagonal braces [8], the guardrails [7] and the access decks [10] (see the Tower Types drawing page 2). Do not add upper ladder frames [6] until the ladder frames [6] below are braced properly.

For the following assembly steps see chapter 5.

### ►5 Assembly of the top working platform

#### Tower Models

1102/1104  
1106/1116  
1108/1110

1202/1204  
1206/1216  
1208/1210

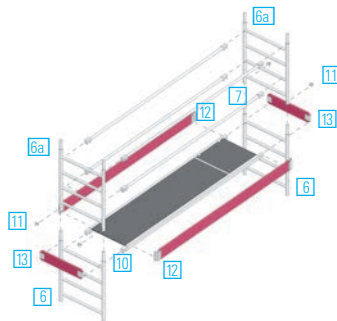

1. Insert the upper ladder frames [6], [6a] and secure them with spring clips [11]. Clip an access deck [10] onto the 5th rung down.

2. Fit the safety protection according to regulations, installing the corresponding four guardrails [7] or two Double guardrails or Uni-Girders [9].

**Assembly of the top working platform**  
Tower Models  
1103, 1105  
1107, 1109  
and 1111  
1124 – 1131  
1145 – 1151

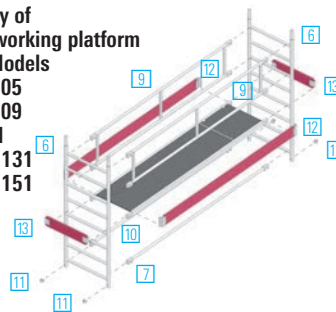

3. Mount the two toe boards 2.85 m [12] between the ladder frames and secure them by adding two end toe boards 0.75 m [13].

**Once mounted push guardrails [7] and Double guardrails [9] outwards as far as possible.**

**Assembly of the top working platform**  
Tower Models  
1203, 1205  
1207, 1209  
and 1211

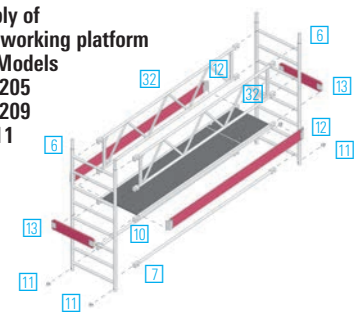

### ►6 Adjustment of the mobile beam

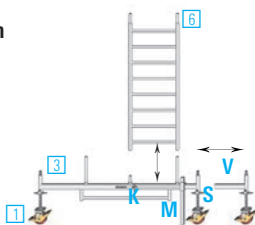

The adjustable mobile beam [3] enables you to work close to a wall. When mounted, it may be extended or retracted. Before adjusting it, make sure the ballast weights indicated in the ballast table are placed in the correct positions (page 12). Before adjustment, lower the center jack (M) fixed to the mobile beam [3] as far as possible and secure it.

Release the castors [1] at the extension arm by winding down the spindle (S) until the extension arm (V), can be moved after loosening the wedge lock (K). Once adjusted, fix the wedge lock (K), and load the castor [1] by winding up the spindle (S) again. Retract the center jack (M) and secure it.



# Assembly

## 7 Operating the castors

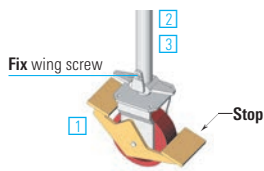

During assembly and while working, the castors 1 must be kept locked by pressing down the brake lever labelled STOP. When the brake is locked, the lever labelled STOP is in the down position. For movement, the castors are unlocked by pushing the other lever down.

## 8 Maximum spindle adjustment of the various models

### Assembly with 1323.180

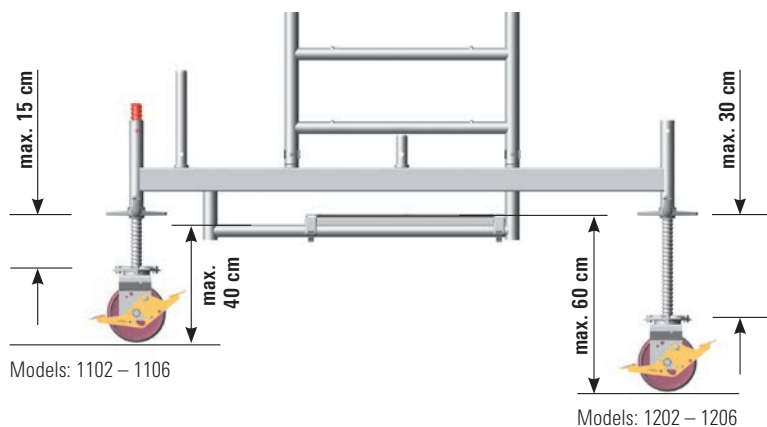

### Assembly directly on castors with access ledger

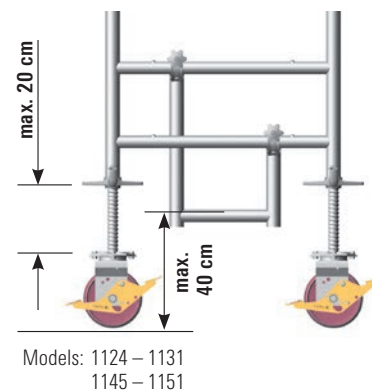

### Assembly with 1323.320

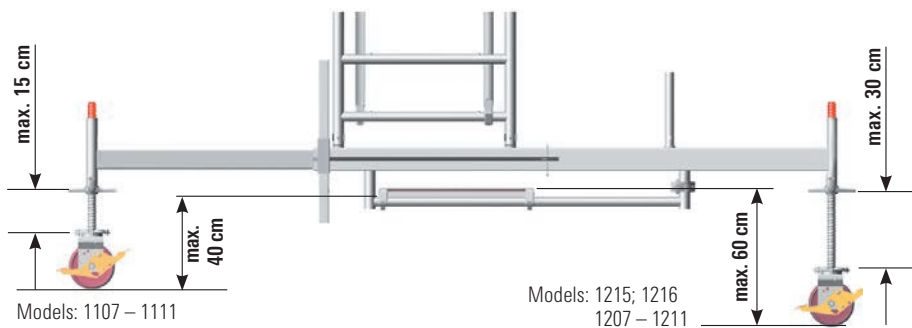

### Assembly directly on castors

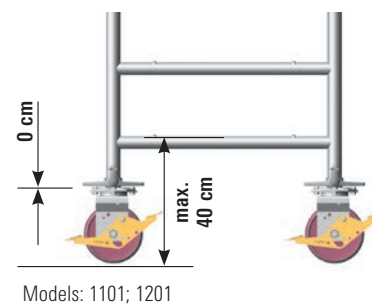

## Wall support

### Wall support under load

Top view

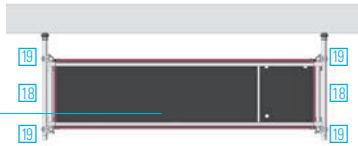

Rolling tower deck 10 14

Top view,  
with mobile beam

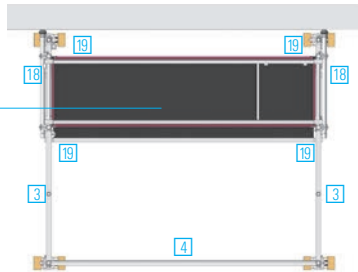

Rolling tower deck 10 14

Side view

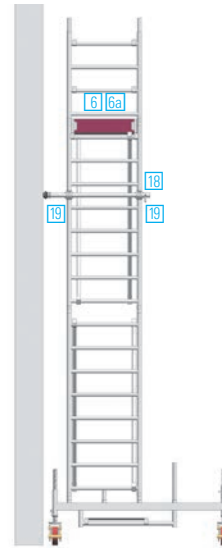

### Layher Uni Standard Tower

For work performed on a load-bearing wall, ballasting can be reduced in accordance with the **Ballasting** table (see pages 12 and 13). In this case, wall supports must be installed on both sides of the tower. Use the Uni distance tube 18 and fix it to the ladder frame 6, 6a with the couplers 19. The mobile beams must be installed so that they project from the side facing away from the wall.

The wall supports must be attached at the height of the top working platform or at most 1 m below that.

Example figure 1204

## Dismantling



**During assembly and dismantling, system decks or scaffolding planks to DIN 4420-3 (minimum dimensions: 28 x 4.5 x 350 cm long) must be installed as auxiliary decks at maximum height intervals of 2.0 m. These auxiliary decks, providing a safe footing for assembly and dismantling, must be removed again after assembly. Each platform must be completely boarded.**

Dismantling is in the reverse order to that of the assembly steps.

**When dismantling, do not remove the bracing elements such as diagonal braces 8, guardrails 7 or access decks 10 until the ladder frames 6 above them have been dismantled.**

To lift out the individual parts, open the snap-on claws by pressing their locking clips. The red locking clips of the decks permit effortless installation and removal by a single person; first open them and place the deck with the opened clips on the rung, then open the opposite clips and lift out the deck.

Towers 1115 and 1116, 1215 and 1216 are intended for **outdoor use**. The tower base must be assembled as described under 2.3.

Tower model	Ref. No.	1101	1102	1103	1104	1105	1115	1106	1116	1107	1108	1109	1110	1111
Ladder frame 75/4	1297.004	–	2	–	2	–	–	2	2	–	2	–	2	–
Ladder frame 75/8	1297.008	2	2	4	4	6	6	6	6	8	8	10	10	12
Access deck 2.85 m	1242.285	1	1	1	1	2	2	2	2	2	2	3	3	3
Double guardrail 2.85 m	1206.285	2	–	2	–	2	2	–	–	2	–	2	–	2
Guardrail 2.85 m	1205.285	–	5	1	5	7	7	9	9	9	11	13	15	15
Diagonal brace 3.35 m	1208.285	–	2	2	4	4	4	6	6	6	8	8	10	10
Mob. beam, fixed, with deck support	1323.180	–	2	2	2	2	–	2	–	–	–	–	–	–
Mob. beam, adj., with deck support	1323.320	–	–	–	–	–	2	–	2	2	2	2	2	2
Base strut 2.85 m	1324.285	–	1	1	1	1	1	1	1	1	1	1	1	1
Toe board 2.85 m, with claw	1239.285	–	2	2	2	2	2	2	2	2	2	2	2	2
End toe board 0.75 m	1238.075	–	2	2	2	2	2	2	2	2	2	2	2	2
Spring clip	1250.000	–	8	8	12	12	12	16	16	16	20	20	24	24
Castor 200 with spindle, 7 kN	1259.200	4	4	4	4	4	4	4	4	4	4	4	4	4
Ballast	1249.000	For the number of ballasting weights see the ballasting table, page 12												

Tower model	Ref. No.	1201	1202	1203	1204	1205	1215	1206	1216	1207	1208	1209	1210	1211
Ladder frame 75/4	1297.004	–	2	–	2	–	–	2	2	–	2	–	2	–
Ladder frame 75/8	1297.008	2	2	4	4	6	6	6	6	8	8	10	10	12
Access deck 2.85 m	1242.285	–	1	1	1	2	2	2	2	2	2	3	3	3
Deck 2.85 m	1241.285	1	1	1	1	1	1	1	1	1	1	1	1	1
Tower beam 2.85 m	1207.285	2	–	2	–	2	2	–	–	2	–	2	–	2
Guardrail 2.85 m	1205.285	–	4	–	4	6	6	8	8	8	10	12	14	14
Diagonal brace 3.35 m	1208.285	–	2	2	4	4	4	6	6	6	8	8	10	10
Mob. beam, fixed, with deck support	1323.180	–	2	2	2	2	–	2	–	–	–	–	–	–
Mob. beam, adj., with deck support	1323.320	–	–	–	–	–	2	–	2	2	2	2	2	2
Base strut 2.85 m	1324.285	–	–	–	–	–	1	–	1	1	1	1	1	1
Basic tube 2.85 m	1211.285	–	1	1	1	1	1	1	1	1	1	1	1	1
Toe board 2.85 m, with claw	1239.285	2	2	2	2	2	2	2	2	2	2	2	2	2
End toe board 0.75 m	1238.075	2	2	2	2	2	2	2	2	2	2	2	2	2
Spring clip	1250.000	–	8	8	12	12	12	16	16	16	20	20	24	24
Castor 200 with spindle, 7 kN	1259.200	4	4	4	4	4	4	4	4	4	4	4	4	4
Ballast	1249.000	For the number of ballasting weights see the ballasting table, page 12												

### Additional requirement for special structure with 2 bracket deck surfaces

Aluminium console bracket 0.75 m	1341.075	–	4	4	4	4	–	4	–	The tower models 1107 – 1111, 1207 – 1211 must not be expanded with bracket deck surfaces				
Deck 2.85 m	1241.285	–	2	2	2	2	–	2	–					
Ladder frame 75/4	1297.004	–	4	4	4	4	–	4	–					
End toe board	1238.075	–	4	4	4	4	–	4	–					
Intermediate deck	1339.285	–	2	2	2	2	–	2	–					
Spring clip	1250.000	–	8	8	8	8	–	8	–					

When operating with brackets, the tower may be loaded with 1.5 kN/m<sup>2</sup> (scaffold group 2) at one working level only. A maximum of 2 bracket deck surfaces may be assembled. For rolling tower models 1102 – 1104, 1202 – 1204, the bracket deck surfaces may not be fitted one above the other. When bracket deck surfaces are fitted, the spindles must not be overextended. When bracket deck surfaces are fitted, the corresponding working level must be equipped with complete side protection.

# Parts list

Assembly variants with stabilizers, extendable: 1124 – 1131; with stabilizer, 5 m: 1145 – 1151

Tower model	Ref. No.	1124	1125		1126	1127		1128		1129		1130		1131	
			1145	1146		1147	1148	1149	1150	1151					
Ladder frame 75/4	1297.004	2	–	–	2	2	–	–	2	2	–	–	2	2	–
Ladder frame 75/8	1297.008	4	6	6	6	6	8	8	8	8	10	10	10	10	12
Access deck 2.85 m	1242.285	1	2	2	2	2	2	2	2	2	3	3	3	3	3
Double guardrail 2.85 m	1206.285	–	2	2	–	–	2	2	–	–	2	2	–	–	2
Guardrail 2.85 m	1205.285	6	8	8	10	10	10	10	12	12	14	14	16	16	16
Diagonal brace 3.35 m	1208.285	4	4	4	6	6	6	6	8	8	8	8	10	10	10
Stabilizer, extendable	1248.260	4	4	–	4	–	4	–	4	–	4	–	4	–	4
Tower support 5 m	1248.500	–	–	4	–	4	–	4	–	4	–	4	–	4	–
Rotation preventer	1248.261	4	4	4	4	4	4	4	4	4	4	4	4	4	4
Toe board 2.85 m, with claw	1239.285	2	2	2	2	2	2	2	2	2	2	2	2	2	2
End toe board 0.75 m	1238.075	2	2	2	2	2	2	2	2	2	2	2	2	2	2
Spring clip	1250.000	8	8	8	12	12	12	12	16	16	16	16	20	20	20
Castor 200 with spindle, 7 kN	1259.200	4	4	4	4	4	4	4	4	4	4	4	4	4	4
Access ledger	1344.002	1	1	1	1	1	1	1	1	1	1	1	1	1	1
Ballast	1249.000	For the number of ballasting weights see the ballasting table, page 13													

# Ballasting

For ballasting, use Layher ballast weights , Ref. No. 1249.000 (10 kg each). A coupler with hand wheel permits simple, quick and secure fixing of the ballast required at the correct places. Only these ballast weights are to be used, **liquid or granular ballast materials must not be used.**

**The ballast weights must be distributed evenly to all ballasting fixing points. The remainder not divisible by 4 must be distributed to the fixing points A.**

Tower model		1101	1102	1103	1104	1105	1115	1106	1116	1107	1108	1109	1110	1111	
		1201	1202	1203	1204	1205	1215	1206	1216	1207	1208	1209	1210	1211	
		l	rSum	l	rSum	l	rSum	l	rSum	l	rSum	l	rSum	l	rSum
Assembly indoors	in centre position	2	2	4	0	0	0	0	0	0	0	0	0	0	0
	in off-centre position	X	X	X	0	0	0	2	2	0	4	4	0	4	4
	off-centre with wall support	X	X	X	0	0	0	0	0	0	0	0	0	0	0
Assembly outdoors	in centre position	2	2	4	0	0	0	1	1	4	4	8	9	18	0
	in off-centre position	X	X	X	0	2	2	0	5	5	0	9	9	2	14
	off-centre with wall support	X	X	X	0	0	0	0	0	0	2	0	2	0	0
<b>Special assembly with brackets</b>															
		l	rSum	l	rSum	l	rSum	l	rSum	l	rSum	l	rSum	l	rSum
Assembly indoors	in centre position (1 bracket)	X	X	X	0	0	0	0	2	2	0	4	4	0	4
	in centre position (2 brackets)	X	X	X	0	0	0	0	0	0	0	0	0	0	0
Assembly outdoors	in centre position (1 bracket)	X	X	X	0	4	4	0	8	8	2	12	14	6	16
	in centre position (2 brackets)	X	X	X	0	2	2	4	4	8	7	9	16	X	X

The figures shown indicate the number of ballast weights of 10 kg each.

○ = no ballast required  
 = example on page 17

× = not permissible

Tower model		1124		1125		1126		1127		1128		1129		1130		1131									
		1224		1225		1226		1227		1228		1229		1230		1231									
		l	r	Sum	l	r	Sum	l	r	Sum	l	r	Sum	l	r	Sum	l	r	Sum						
Assembly indoors	in centre position	0	0	○	0	0	○	0	0	○	0	0	○	0	0	○	0	0	○	0	0	○			
		<b>l R Sum</b>		<b>l R Sum</b>		<b>l R Sum</b>		<b>l R Sum</b>		<b>l R Sum</b>		<b>l R Sum</b>		<b>l R Sum</b>		<b>l R Sum</b>		<b>l R Sum</b>							
	in off-centre position	0	7	7	0	9	9	0	11	11	0	14	14	0	16	16	0	18	18	0	21	21	0	23	23
	<b>l R Sum</b>		<b>l R Sum</b>		<b>l R Sum</b>		<b>l R Sum</b>		<b>l R Sum</b>		<b>l R Sum</b>		<b>l R Sum</b>		<b>l R Sum</b>		<b>l R Sum</b>		<b>l R Sum</b>						
	off-centre with wall support	0	0	○	0	0	○	0	0	○	0	0	○	0	0	○	0	0	○	0	0	○	0	0	○
		<b>l r Sum</b>		<b>l r Sum</b>		<b>l r Sum</b>		<b>l r Sum</b>		<b>l r Sum</b>		<b>l r Sum</b>		<b>l r Sum</b>		<b>l r Sum</b>		<b>l r Sum</b>							
Assembly outdoors	in centre position	0	0	○	0	0	○	0	0	○	2	2	4	×	×	×	×	×	×	×	×	×	×	×	×
		<b>l R Sum</b>		<b>l R Sum</b>		<b>l R Sum</b>		<b>l R Sum</b>		<b>l R Sum</b>		<b>l R Sum</b>		<b>l R Sum</b>		<b>l R Sum</b>		<b>l R Sum</b>		<b>l R Sum</b>		<b>l R Sum</b>			
	in off-centre position	0	13	13	0	19	19	0	23	23	0	31	31	×	×	×	×	×	×	×	×	×	×	×	×
	<b>l R Sum</b>		<b>l R Sum</b>		<b>l R Sum</b>		<b>l R Sum</b>		<b>l R Sum</b>		<b>l R Sum</b>		<b>l R Sum</b>		<b>l R Sum</b>		<b>l R Sum</b>		<b>l R Sum</b>		<b>l R Sum</b>				
	off-centre with wall support	0	0	○	0	0	○	0	0	○	2	2	4	×	×	×	×	×	×	×	×	×	×	×	×
		<b>l r Sum</b>		<b>l r Sum</b>		<b>l r Sum</b>		<b>l r Sum</b>		<b>l r Sum</b>		<b>l r Sum</b>		<b>l r Sum</b>		<b>l r Sum</b>		<b>l r Sum</b>		<b>l r Sum</b>					

Tower model		1145		1146		1147		1148		1149		1150		1151							
		1245		1246		1247		1248		1249		1250		1251							
		l	r	Sum	l	r	Sum	l	r	Sum	l	r	Sum	l	r	Sum					
Assembly indoors	in centre position	0	0	○	0	0	○	0	0	○	0	0	○	0	0	○	0	0	○		
		<b>l R Sum</b>		<b>l R Sum</b>		<b>l R Sum</b>		<b>l R Sum</b>		<b>l R Sum</b>		<b>l R Sum</b>		<b>l R Sum</b>							
	in off-centre position	0	5	5	0	7	7	0	9	9	0	10	10	0	12	12	0	13	13	0	15
	<b>l R Sum</b>		<b>l R Sum</b>		<b>l R Sum</b>		<b>l R Sum</b>		<b>l R Sum</b>		<b>l R Sum</b>		<b>l R Sum</b>								
	off-centre with wall support	0	0	○	0	0	○	0	0	○	0	0	○	0	0	○	0	0	○		
		<b>l r Sum</b>		<b>l r Sum</b>		<b>l r Sum</b>		<b>l r Sum</b>		<b>l r Sum</b>		<b>l r Sum</b>									
Assembly outdoors	in centre position	0	0	○	0	0	○	×	×	×	×	×	×	×	×	×	×	×	×		
		<b>l R Sum</b>		<b>l R Sum</b>		<b>l R Sum</b>		<b>l R Sum</b>		<b>l R Sum</b>		<b>l R Sum</b>		<b>l R Sum</b>							
	in off-centre position	0	14	14	0	17	17	×	×	×	×	×	×	×	×	×	×	×	×		
	<b>l R Sum</b>		<b>l R Sum</b>		<b>l R Sum</b>		<b>l R Sum</b>		<b>l R Sum</b>		<b>l R Sum</b>		<b>l R Sum</b>								
	off-centre with wall support	0	0	○	0	0	○	0	0	○	×	×	×	×	×	×	×	×	×		
		<b>l r Sum</b>		<b>l r Sum</b>		<b>l r Sum</b>		<b>l r Sum</b>		<b>l r Sum</b>		<b>l r Sum</b>									

The number of weights not divisible by four must be distributed diagonally.

The figures shown indicate the number of ballast weights of 10 kg each.

○ = no ballast required

× = not permissible

# ▶ Ballasting

## ▶ Attachment of ballast weights

### Centre position:

Models:

1101  
1201

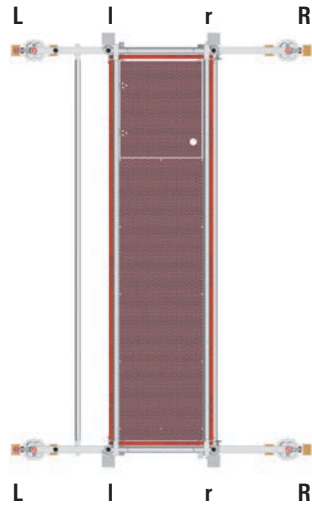
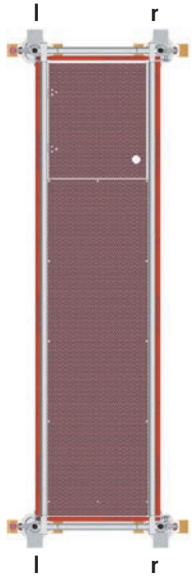

Models:

1102 – 1106  
1202 – 1206

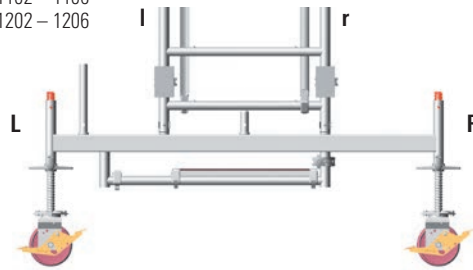

Models:

1107 – 1111  
1115 and 1116  
1207 – 1211  
1215 and 1216

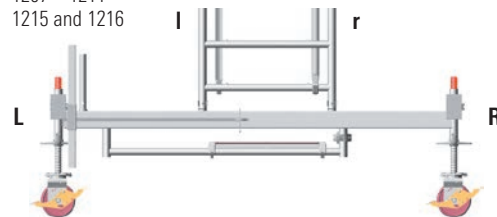

## Layher Uni Standard Tower

Models:

1124 – 1131  
1145 – 1151

(also applicable for  
assembly with tower  
beam similar to 12...)

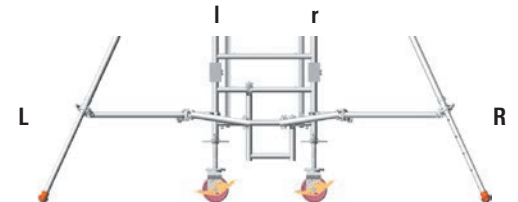
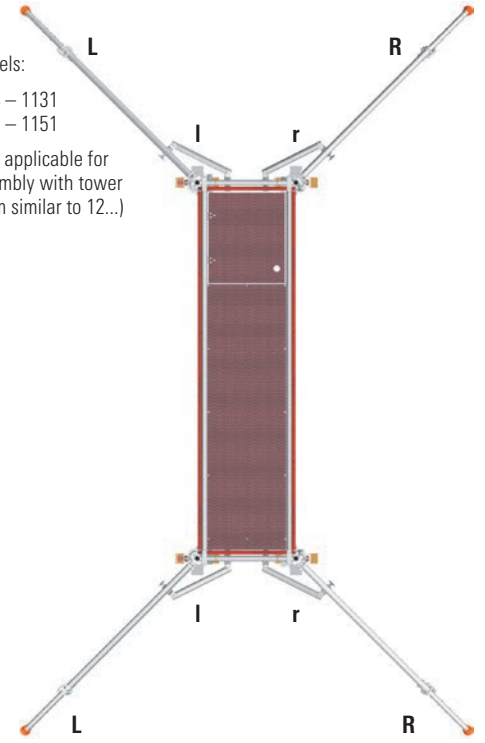

# ▶ Ballasting

## ▶ Attachment of ballast weights

Off-centre position:

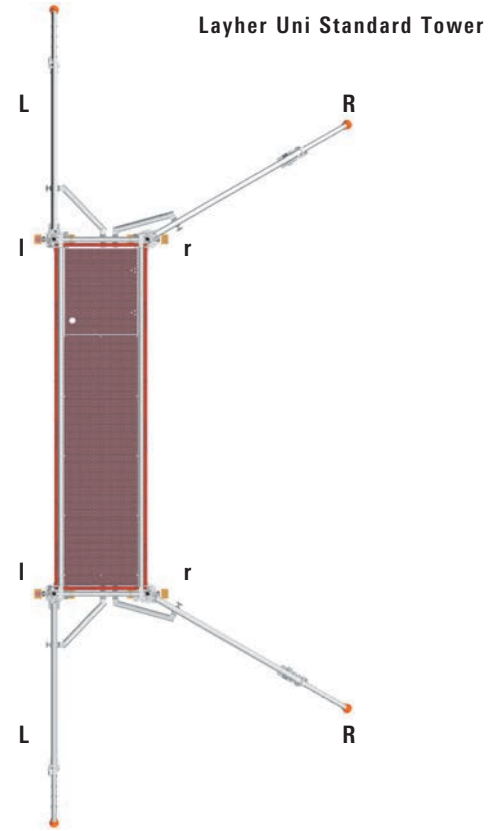
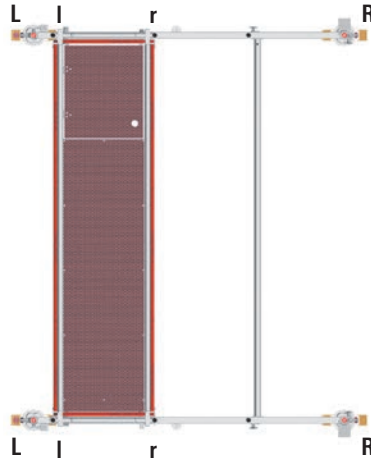
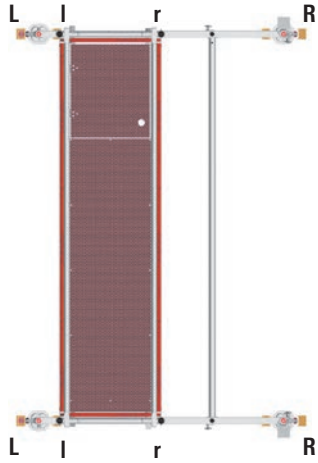

Models:

1102 – 1106  
1202 – 1206

Models:

1107 – 1111  
1115 and 1116  
1207 – 1211  
1215 and 1216

Models:

1124 – 1131  
1145 – 1151

(also applicable for  
assembly with tower  
beam similar to 12...)

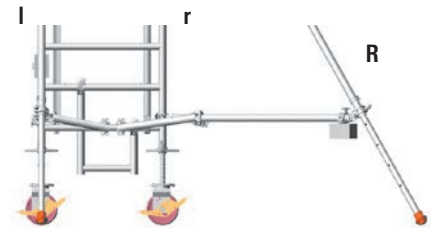
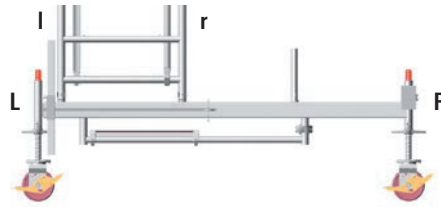
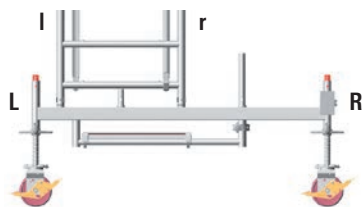

# ▶ Ballasting

## ▶ Attachment of ballast weights

Centre position with brackets:

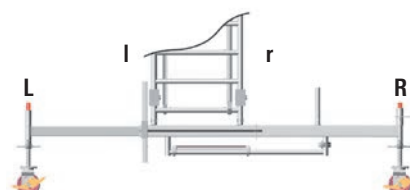
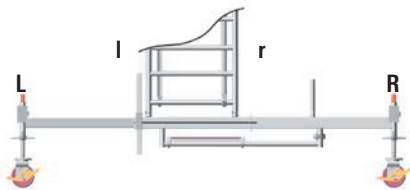
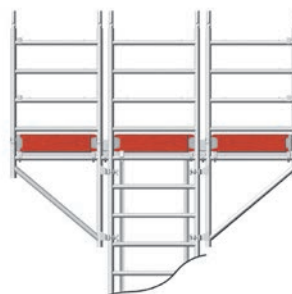
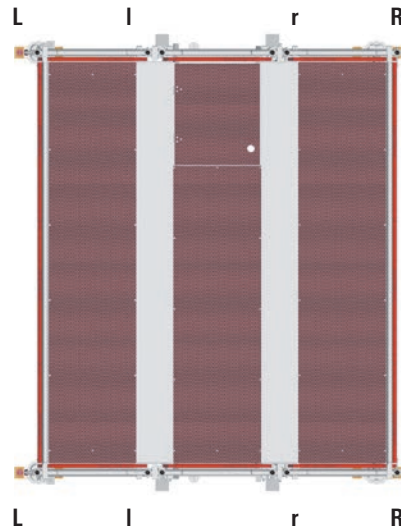
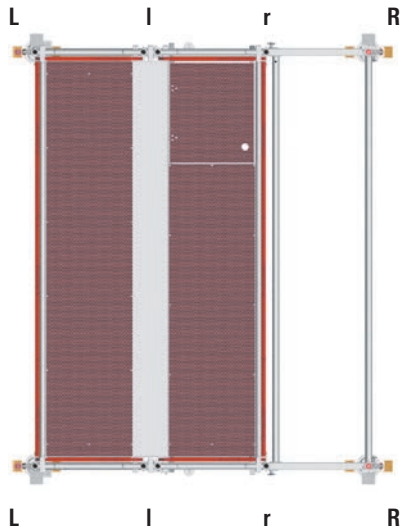



# ▶ Ballasting

## ▶ Attachment of ballast weights

Double structure:

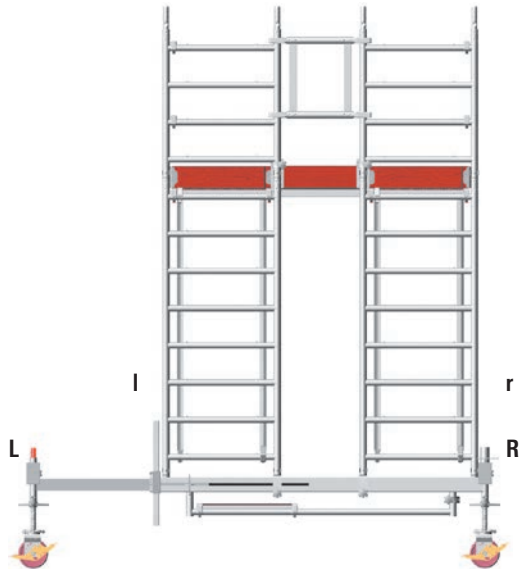
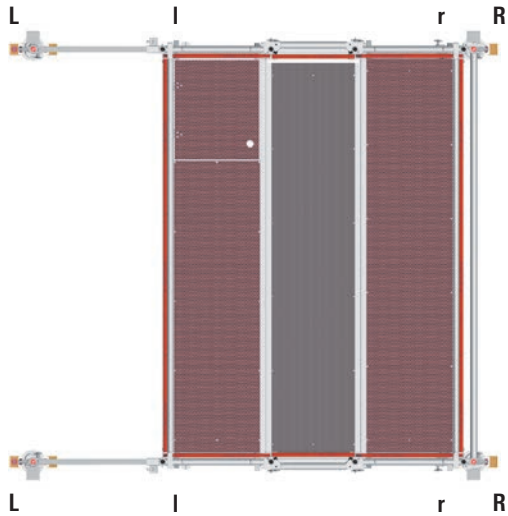

Layher Uni Standard Tower

## ▶ Example of assembly, model 1104

Assembly outdoors in off-centre position  
Ballast: see excerpt from Table, page 12



1104		
1204		
l	r	Sum
0	0	○
0	4	4
0	0	○
4	4	8
0	9	9

# Stabilizer attachment

Read and understand item 1 "Basic Assembly for Rolling Tower Types Without Mobile Beams" on page 6 before assembly. The fixed and adjustable mobile beams are not included when assembled this way. They are replaced by extendable stabilizers [21].

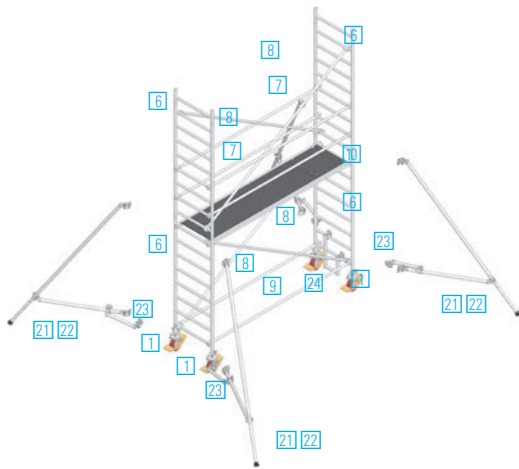

Attach a stabilizer [21] [22] to every stile of the ladder frame [6]. To do so, attach the half-coupler directly underneath the rung of the ladder frame [6]. Before tightening the star-knobs (hand wheels), fix the stabilizers in the correct position against the wall, or free-standing, then tighten using the star-knobs. Move the half-coupler on the stabilizer to make sure that the foot is standing firmly on the ground. Fasten the lower half-coupler above the lowest rung of the ladder frame [6] and tighten it with the star-knob.

The position of the stabilizers must be adjusted as follows:

Free-standing assembly: each about 60° to the long side of the tower (illustration on the left).

Assembly against a wall: On the wall side, about 90° to the end face of the tower, and on the side away from the wall at about 60° to the long side of the tower (illustration on the right).

To ensure that the position cannot change, now attach the rolling tower rotation lock [23] to the stabilizer [21] [22] and to the rung of the ladder frame [6].

Adjust the rolling tower rotation preventer by moving the half-coupler on the stabilizer [21] [22] such that the half-coupler is fastened underneath the first rung of the ladder frame. It must be ensured that the locking pins engage securely in the telescoping parts on the scaffold frame in such a way that they can be withdrawn. When moving the rolling tower, the stabilizer must be lifted no more than 2 cm from the ground.

For work to be carried out on a wall that can support a load, the ballasting may be done in accordance with the ballasting table (see page 13).

For further assembly of tower models 1124 – 1127 and 1145 – 1147 see section 5.

For further assembly of tower models 1128 – 1131 and 1148 – 1151 see section 4.

Free-standing assembly

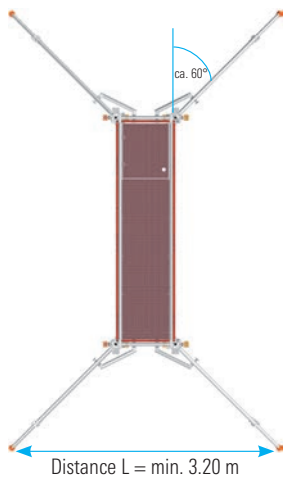



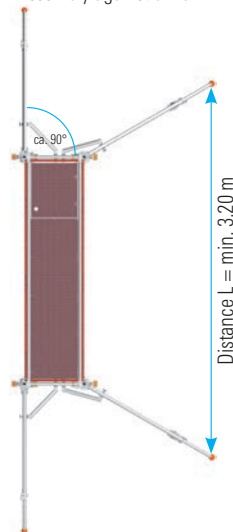













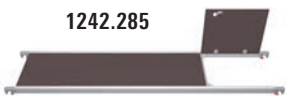





Assembly against a wall



After the stabilizers have been fitted, the angles mentioned above can be checked using the "Distance L" dimension.







# Components

<b>1</b>	<b>Castor 200</b> with spindle, 7 kN	<b>1259.200</b>	
<b>2</b>	<b>Mobile beam with bar</b> 1.8 m	<b>1323.180</b>	
<b>3</b>	<b>Mobile beam with bar</b> 3.2 m adjustable	<b>1323.320</b>	
<b>5</b>	<b>Base strut</b> 2.85 m	<b>1324.285</b>	
<b>6a</b>	<b>Ladder frame 75/4</b>	<b>1297.004</b>	
<b>6</b>	<b>Ladder frame 75/8</b>	<b>1297.008</b>	
<b>7</b>	<b>Guardrail</b> 2.85 m	<b>1205.285</b>	
<b>8</b>	<b>Diagonal brace</b> 3.35 m	<b>1208.285</b>	
<b>9</b>	<b>Double guardrail</b>	<b>1206.285</b>	
<b>10</b>	<b>Access deck</b> 2.85 m	<b>1242.285</b>	
<b>11</b>	<b>Spring clip</b>	<b>1250.000</b>	
<b>12</b>	<b>Toe board with claw</b> 2.85 m	<b>1239.285</b>	

<b>13</b>	<b>End toe board</b> 0.75 m	<b>1238.075</b>	
<b>14</b>	<b>Deck</b> 2.85 m	<b>1241.285</b>	
<b>15</b>	<b>Horizontal diagonal brace</b> adjustable	<b>1318.000</b>	
<b>Mobile beam support, bolt on</b>			
<b>16</b>	1.0 m	<b>1325.100</b>	
<b>17</b>	1.4 m	<b>1325.140</b>	
<b>18</b>	<b>Uni distance tube</b> 1.1 m	<b>1275.110</b>	
<b>19</b>	<b>Special tower screw coupler, rigid</b>		
	19 mm WS	<b>1269.019</b>	
	22 mm WS	<b>1269.022</b>	
<b>20</b>	<b>Ballast (10 kg)</b>	<b>1249.000</b>	
<b>21</b>	<b>Stabilizer extendable</b>	<b>1248.260</b>	
<b>22</b>	<b>Stabilizer</b> 5 m	<b>1248.500</b>	
<b>23</b>	<b>Tower rotation lock</b>	<b>1248.261</b>	
<b>24</b>	<b>Access ledger</b>	<b>1344.002</b>	
<b>4</b>	<b>Basic tube</b> 2.85 m	<b>1211.285</b>	

## Layher Uni Standard Tower

# Components for special assemblies

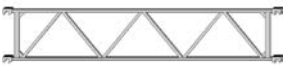
<b>25</b>	<b>Aluminium bracket</b> 0.75 m	<b>1341.075</b>	
<b>26</b>	<b>Intermediate deck</b> 2.85 m	<b>1339.285</b>	
<b>27</b>	<b>Special mobile beam adjustable</b>	<b>1338.320</b>	
<b>28</b>	<b>Spigot adjustable</b>	<b>1337.000</b>	
<b>29</b>	<b>Bridging deck</b> 2.85 m	<b>1343.285</b>	
<b>30</b>	<b>Guardrail</b> 0.58 m	<b>1342.058</b>	
<b>31</b>	<b>Toe board</b> 0.6 m	<b>1340.060</b>	
<b>32</b>	<b>Beam</b> 2.85 m	<b>1207.285</b>	

**Identification sign**  
6344.300

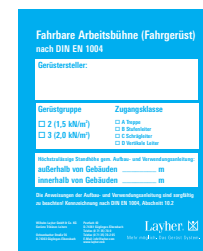

**Prohibition sign**  
6344.200





# Special assembly with bridging

Layher Uni Standard Tower

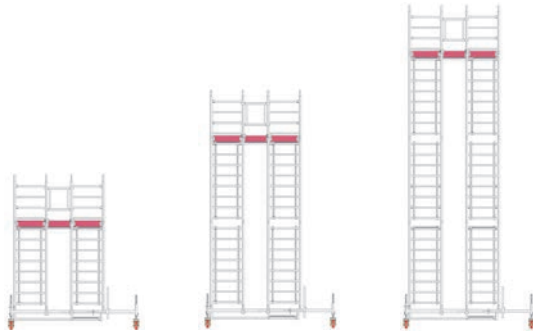

Tower model	1302	1304	1306
Working height (m)	4.6	6.4	8.4
Scaffolding height (m)	3.64	5.64	7.64
Platform height (m)	2.4	4.4	6.4
Weight (kg)	361.7	413.3	508.1

## Ballasting

The figures shown indicate the number of ballast weights of 10 kg each.

○ = no ballast required × = not permissible

### Double structure on extended mobile beam (1323.320) with and without tower beam

Tower model	1302			1304			1306		
	L	R	Sum	L	R	Sum	L	R	Sum
Assembly indoors	0	0	○	0	0	○	0	0	○
Assembly outdoors	2	2	4	0	0	○	6	0	6

## 1 Basic assembly

1. Observe the general instructions for assembly and use on page 28.

The special assemblies 1302, 1304 and 1306 correspond to the double Uni Standard towers 1102, 1104, 1106, or 1202, 1204 and 1206. No other assembly forms are permitted.

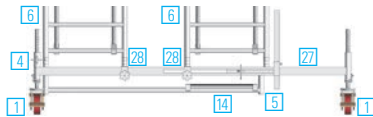

No ballasting is necessary for outdoor assembly either.

**The maximum assembly height with a platform height of 6.30 m must be observed without fail.**

**The castors must not be fully extended.**

**The tower may be loaded with max. 1.5 kN/m<sup>2</sup> (scaffold group 2) at one working level only.**

2. Insert the castors (1) into the special mobile beam with adjustable spigot (28) and secure them against falling out by tightening the wing screws on the spindle nuts.

3. Connect the mobile beams (27) by a basic tube (4). The basic tube (4) is fitted onto the projecting spigots at the ends of the mobile beams (27) and **wedged tight** after adjustment. Suspend the deck (14) from the support of the mobile beam (27). Then clamp the base strut (5) to the leg of the mobile beam support (27).

4. Attach 2 adjustable spigots (28) as shown in the drawing to the adjustable special mobile beam (26) and **tighten** the screws of the adjustable spigot (28).

## 2 Assembly of intermediate and top working platforms

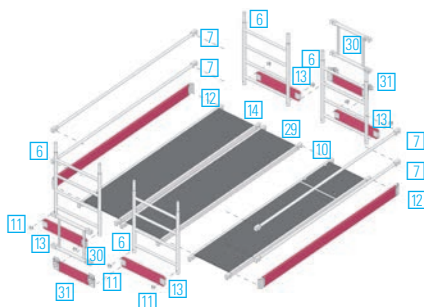

5. The further assembly of the ladder frames (6) and of the diagonal braces (8), guardrail (7) and access decks (10) is in accordance with sections 2.3 to 4.0 (see pages 6 – 8). Ensure that the deck (14) is placed centrally beneath the ladder frame (6), with the ladder frame (6) placed on the adjusting part of the mobile beam (26) determining the position.

6. When assembling the top working platform, omit the guardrails and toe boards on the inside. Now move the access deck (10) and the deck (14) apart to insert the bridge deck (29) between the decks into the ladder frames (6). This creates a closed working surface. Move the decks back together after installation so that the maximum gap of 25 mm.

7. Now snap 2 guardrails, 0.58 m (30) onto the ladder frames (6), (6a). Place 2 toe boards 0.6 m (31) on the bridge deck 2.85 m (29) and connect them using half-couplers to the ladder frames (6), (6a). Complete the side protection with 4 end toe boards 0.75 m (32) and 2 toe boards 2.85 m (32).

8. Dismantling is in the reverse order. To do so, follow the dismantling sequence (see page 10).

**During assembly and dismantling, system decks or scaffolding planks to DIN 4420 (minimum dimensions: 28 x 4.5 x 350 cm long) must be installed as auxiliary decks at maximum height intervals of 2.0 m. These auxiliary decks, providing a safe footing for assembly and dismantling, must be removed again after assembly. Each platform must be completely boarded.**

# Special assembly with bridging

## 3 Parts list for special assembly with 2 Uni Standard towers on special mobile beams, adjustable

Tower model	Ref. No.	1302	1304	1306
Ladder frame 75/4	1297.004	4	4	4
Ladder frame 75/8	1297.008	4	8	12
Access deck 2.85 m	1242.285	1	1	2
Deck 2.85 m	1241.285	2	2	2
Tower beam 2.85 m	1207.285	–	–	–
Guardrail 2.85 m	1205.285	8	8	14
Mobile beam 3.2 m, adjustable	1338.320	2	2	2
Spigot, adjustable	1337.000	4	4	4
Diagonal braces 3.35 m, adjustable	1208.285	4	8	12
Base strut 2.85 m	1324.285	1	1	1
Base tube 2.85 m	1211.285	1	1	1
Bridge deck	1343.285	1	1	1
Guardrail 0.58 m	1342.058	2	2	2
Toe board 0.6 m	1340.060	2	2	2
End toe board 0.75 m	1238.075	4	4	4
Toe board 2.85 m, with claw	1239.285	2	2	2
Spring clip	1250.000	16	24	32
Castor 200 with spindle, 7 kN	1259.200	4	4	4

The maximum platform height is 6.3 m, for these applications ballasting is not necessary.

## Assembly of special mobile beam, adjustable

Ballasting must in any event be in accordance with the ballasting table, column for **off-centre position** (see page 12).

**The ballast weights must be distributed evenly to the fixing points A in the drawing. The assembly instructions must be precisely followed here.**

Move the spigots on the mobile beam 27 in such a way that the ladder frames 6 can be fitted in the different positions.

For this purpose, both fixed and adjustable spigots 28 can be used. **Tighten** the bolts of the adjustable spigot.

Level the tower using the adjusting spindles. For further assembly see section 2.3.

**Tower assembly centred**

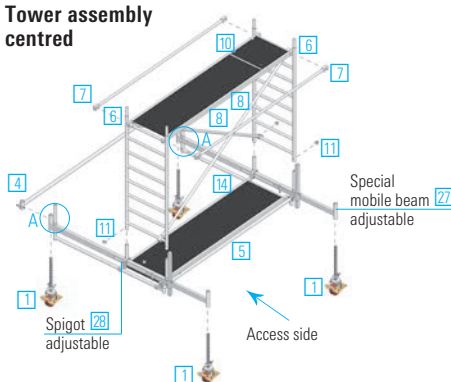

**Tower assembly off-centre**

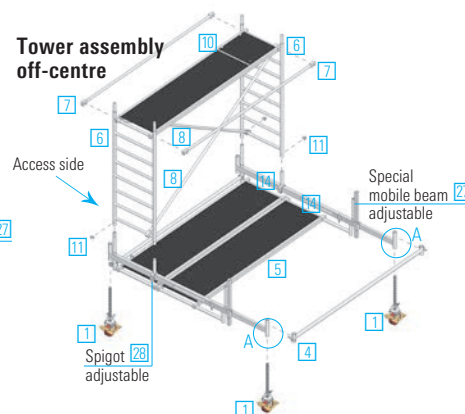

**Tower assembly off-centre**

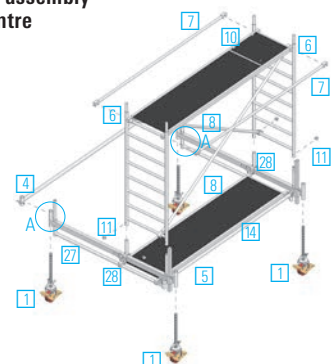

ZERTIFIKAT ◆ CERTIFICATE ◆ 認証証書 ◆ CERTIFICADO ◆ CERTIFICAT





## CERTIFICATE

No. Z1A 08 02 19959 053

**Holder of Certificate:** Wilhelm Layher GmbH & Co. KG  
 Ochsenbacher Straße 56  
 74363 Göglingen-Eibensbach  
 GERMANY

**Factory(ies):** 19959

**Certification Mark:**

**Product:** Scaffold

**Model(s):** UniStandard

**Parameters:** see attachment 1

**Tested according to:** DIN EN 1004:2005  
 DIN EN 1298:1996



The product meets the requirements of the German Equipment and Product Safety Act. The Certification marks shown above can be affixed on the product. The certification marks must not be altered in any way. The use of the GS-Mark is permitted until the listed date, the use of the TÜV-Mark is unlimited, unless it is cancelled. See also notes overleaf.

**Test report no.:** 028-71320787-001

**GS-Mark valid until:** 2013-03-03

**Date,** 2008-10-13  
 Page 1 of 7

TÜV SÜD Product Service GmbH · Zertifizierstelle · Ridlerstrasse 65 · 80339 München · Germany



ZERTIFIKAT ◆ CERTIFICATE ◆ 證書 ◆ CERTIFICADO ◆ CERTIFICAT



## CERTIFICATE

No. Z1A 08 02 19959 053

**Holder of Certificate:** Wilhelm Layher GmbH & Co. KG  
Ochsenbacher Straße 56  
74363 Gügingen-Eibensbach  
GERMANY

**Factory(ies):** 19959

**Certification Mark:** 

**Product:** Scaffold

**Model(s):** UniStandard

**Parameters:** see attachment 1

**Tested according to:** DIN EN 1004:2005  
DIN EN 1298:1996

The product meets the requirements of the German Equipment and Product Safety Act. The Certification marks shown above can be affixed on the product. The certification marks must not be altered in any way. The use of the GS-Mark is permitted until the listed date, the use of the TÜV-Mark is unlimited, unless it is cancelled. See also notes overleaf.

**Test report no.:** 028-71320787-001

**GS-Mark valid until:** 2013-03-03

**Date,** 2008-10-13  
Page 1 of 7





TÜV SÜD Product Service GmbH · Zertifizierstelle · Ridlerstrasse 65 · 80339 München · Germany

TUV®

AT 1 03 08

ZERTIFIKAT ◆ CERTIFICATE ◆ 證書 ◆ CERTIFICADO ◆ CERTIFICAT



## CERTIFICATE

No. Z1A 08 02 19959 053

**Holder of Certificate:** Wilhelm Layher GmbH & Co. KG  
Ochsenbacher Straße 56  
74363 Gügingen-Eibensbach  
GERMANY

**Factory(ies):** 19959

**Certification Mark:** 

**Product:** Scaffold

**Model(s):** UniStandard

**Parameters:** see attachment 1

**Tested according to:** DIN EN 1004:2005  
DIN EN 1298:1996

The product meets the requirements of the German Equipment and Product Safety Act. The Certification marks shown above can be affixed on the product. The certification marks must not be altered in any way. The use of the GS-Mark is permitted until the listed date, the use of the TÜV-Mark is unlimited, unless it is cancelled. See also notes overleaf.

**Test report no.:** 028-71320787-001

**GS-Mark valid until:** 2013-03-03

**Date,** 2008-10-13  
Page 1 of 7

TÜV SÜD Product Service GmbH · Zertifizierstelle · Ridlerstrasse 65 · 80339 München · Germany

TUV®

AT 1 03 08



ZERTIFIKAT ◆ CERTIFICATE ◆ 證書 ◆ CERTIFICADO ◆ CERTIFICAT



## CERTIFICATE

No. Z1A 08 02 19959 053

**Holder of Certificate:** Wilhelm Layher GmbH & Co. KG  
Ochsenbacher Straße 56  
74363 Gügingen-Eibensbach  
GERMANY

**Factory(ies):** 19959

**Certification Mark:**



**Product:** Scaffold

**Model(s):** UniStandard

**Parameters:** see attachment 1

**Tested according to:** DIN EN 1004:2005  
DIN EN 1298:1996

The product meets the requirements of the German Equipment and Product Safety Act. The Certification marks shown above can be affixed on the product. The certification marks must not be altered in any way. The use of the GS-Mark is permitted until the listed date, the use of the TÜV-Mark is unlimited, unless it is cancelled. See also notes overleaf.

**Test report no.:** 028-71320787-001

**GS-Mark valid until:** 2013-03-03

**Date,** 2008-10-13  
Page 1 of 7





TÜV SÜD Product Service GmbH · Zertifizierstelle · Ridlerstrasse 65 · 80339 München · Germany

TUV®

AT 1 03 00

ZERTIFIKAT ◆ CERTIFICATE ◆ 證書 ◆ CERTIFICADO ◆ CERTIFICAT



## CERTIFICATE

No. Z1A 08 02 19959 053

**Holder of Certificate:** Wilhelm Layher GmbH & Co. KG  
Ochsenbacher Straße 56  
74363 Gügingen-Eibensbach  
GERMANY

**Factory(ies):** 19959

**Certification Mark:**



**Product:** Scaffold

**Model(s):** UniStandard

**Parameters:** see attachment 1

**Tested according to:** DIN EN 1004:2005  
DIN EN 1298:1996

The product meets the requirements of the German Equipment and Product Safety Act. The Certification marks shown above can be affixed on the product. The certification marks must not be altered in any way. The use of the GS-Mark is permitted until the listed date, the use of the TÜV-Mark is unlimited, unless it is cancelled. See also notes overleaf.

**Test report no.:** 028-71320787-001

**GS-Mark valid until:** 2013-03-03

**Date,** 2008-10-13  
Page 1 of 7





TÜV SÜD Product Service GmbH · Zertifizierstelle · Ridlerstrasse 65 · 80339 München · Germany

TUV®

AT 1 03 00

ZERTIFIKAT ◆ CERTIFICATE ◆ CERTIFICADO ◆ СЕРТИФИКАТ ◆ 證書



## CERTIFICATE

No. Z1A 08 02 19959 053

**Holder of Certificate:** Wilhelm Layher GmbH & Co. KG  
Ochsenbacher Straße 56  
74363 Güglingen-Eibensbach  
GERMANY

**Factory(ies):** 19959

**Certification Mark:**



**Product:** Scaffold

**Model(s):** UniStandard

**Parameters:** see attachment 1



**Tested according to:** DIN EN 1004:2005  
DIN EN 1298:1996

The product meets the requirements of the German Equipment and Product Safety Act. The Certification marks shown above can be affixed on the product. The certification marks must not be altered in any way. The use of the GS-Mark is permitted until the listed date, the use of the TÜV-Mark is unlimited, unless it is cancelled. See also notes overleaf.

**Test report no.:** 028-71320787-001

**GS-Mark valid until:** 2013-03-03

**Date,** 2008-10-13  
Page 1 of 7





TÜV SÜD Product Service GmbH · Zertifizierstelle · Ridlerstrasse 65 · 80339 München · Germany

TUV®

AT 1 03 08

ZERTIFIKAT ◆ CERTIFICATE ◆ CERTIFICADO ◆ СЕРТИФИКАТ ◆ 證書





## CERTIFICATE

No. Z1A 08 02 19959 053

**Holder of Certificate:** Wilhelm Layher GmbH & Co. KG  
Ochsenbacher Straße 56  
74363 Güglingen-Eibensbach  
GERMANY

**Factory(ies):** 19959

**Certification Mark:**

**Product:** Scaffold

**Model(s):** UniStandard

**Parameters:** see attachment 1



**Tested according to:** DIN EN 1004:2005  
DIN EN 1298:1996

The product meets the requirements of the German Equipment and Product Safety Act. The Certification marks shown above can be affixed on the product. The certification marks must not be altered in any way. The use of the GS-Mark is permitted until the listed date, the use of the TÜV-Mark is unlimited, unless it is cancelled. See also notes overleaf.

**Test report no.:** 028-71320787-001

**GS-Mark valid until:** 2013-03-03

**Date,** 2008-10-13  
Page 1 of 7

TÜV SÜD Product Service GmbH · Zertifizierstelle · Ridlerstrasse 65 · 80339 München · Germany

TUV®

AT 1 03 08



# General directions for assembly and use

## Layher Uni Standard Tower

The rolling tower may be used for the scaffolding group as specified in DIN EN 1004.

### The user of the rolling tower must comply with the following instructions:

1. The user must check the suitability of the selected rolling tower for the work to be performed (Section 4 of BetrSichV – German Ordinance on Industrial Safety and Health).

2. According to DIN EN 1004:2005-03 the maximum platform height is

- 12.0 m when inside buildings
- 8.0 m when outside buildings

The specifications governing ballasting and components on pages 11 – 13 must be observed. There is a risk of accident if this is not done. Stability and load-bearing capacity are no longer assured. Any variations in assembly that differ from the specifications may require additional design measures. In such a case, the stability and load-bearing capacity would have to be verified for the individual case.

3. The assembly, modification or dismantling of the rolling tower in accordance with the present instructions for assembly and use may only be performed under the supervision of a qualified expert and by technically trained employees after special instruction. Only the scaffolding types shown in these instructions for assembly and use may be used. After assembly and before being put into service, the equipment must be inspected by persons qualified to do so (Sections 4 and 10 of BetrSichV). The inspection must be documented (Section 11 of BetrSichV). During assembly, modification or dismantling, the rolling tower must be provided with a prohibition sign indicating “No access allowed” and be adequately safeguarded by means of barriers preventing access to the danger zone (BetrSichV Annex 2, para. 5.2.5).

4. Before installation, all parts must be inspected to ensure they are in perfect condition. Only undamaged original parts from Layher's mobile working platform systems may be used. Scaffolding parts such as snap-on claws and spigots must be cleaned of dirt after use. Scaffolding components must be secured against slipping and impacts when transported by truck. Scaffolding components must be handled in such a way that they are not damaged. See the tables on pages 12 – 13 of these instructions for wall bracing and attachment of the ballast weights.

5. In order to assemble the upper sections of the rolling tower, the individual parts must be handed up from one level to the next. Tools and small amounts of materials can be carried up by the personnel, otherwise hoisted up to the working level using transport ropes.

6. The ladder frame joints must always be secured with locking pins.

7. Suitable materials must be inserted underneath to ensure that the scaffolding is perpendicular. The permitted deviation from the perpendicular must not be more than 1%.

8. Stability must be ensured at every phase of assembly.

9. Toe boards can be omitted from intermediate platforms that are only used for ascent. Small towers in which the deck surface is more than 1.00 m high must include equipment that permits attachment of side protection in accordance with DIN EN 1004:2005-03.

10. Access up to the working platform is generally only permitted on the inside of the scaffolding. Scaffolding types with an assembly height of less than 1 m are an exception to this rule.

11. Work must not take place on two or more working levels at the same time. The manufacturer must be consulted regarding any variations. If work is to take place on more than one level, they must be fully fitted with 3-piece side protection.

12. It is not permitted to push against adjacent objects (such as walls) when working on mobile working platforms.

13. Lifting gear must not be attached to or used on mobile working platforms.

14. Assembly and movement is only permitted on sufficiently strong surfaces, and only in the longitudinal direction or diagonally. All impacts must be avoided. If the base is widened on one side with wall bracing, movement must always be parallel to the wall. Movement should not be faster than normal walking pace.

15. No personnel and/or loose objects may be on the tower while it is being moved.

16. After movement, the wheels must be locked by pressing down the brake lever.

17. The towers must not be subjected to any aggressive fluids or gases.

18. Mobile working platforms must not be connected by bridging unless a special verification of structural stability is provided. The same applies to all special structures such as suspended scaffolding. The attachment of any bridging elements between one mobile working platform and a building is also not permitted.

**19. When used in the open air, or in open buildings, the mobile working platform must be moved to an area protected from the wind or secured by other suitable means to prevent it falling over if the wind strength exceeds 6 on the Beaufort scale, or at the end of the working shift.** (Wind that exceeds strength 6 can be recognized from the difficulty felt when walking into the wind.) If possible, rolling towers used outside buildings should be securely fastened to the building or to some other structure. It is recommended that mobile working platforms are anchored down if they are left unsupervised. The scaffolding must be aligned perpendicular either by use of the compensating screw, or by inserting suitable materials underneath. The permitted deviation from the perpendicular must not be more than 1%.

20. Decks can also be raised or lowered one rung in order to obtain a different working height. In that case it is necessary to make sure that the specified side protection heights of 1.0 m and 0.5 m are maintained. When assembled this way, deck diagonals are to be used.

**The manufacturer must be consulted regarding a stability verification.**

21. The access hatches must always be kept closed except when climbing through them.

22. All couplers are to be tightened up to 50 Nm.

23. It is forbidden to climb over from rolling towers.

24. Jumping onto the deck surfaces is forbidden.

25. A check must be made on whether all the parts, auxiliary tools and safety equipment (ropes etc.) needed for assembly of the mobile working platforms are available on the building site.

26. Horizontal and vertical loads that could cause the mobile working platform to tip over must be avoided. These include:

- forces caused by pushing against adjacent objects (e.g. walls)
- additional wind loads (the tunnel effect of buildings with through-passages, buildings without facings or building corners).

27. Mobile beams, stabilizers or outriggers and ballast must be installed if specified.

28. It is forbidden to increase the height of the deck surfaces by using ladders, boxes or any other objects.

29. Mobile working platforms are not designed to be lifted or suspended.

30. The item numbers for components given in blue in the text refer to the list of individual parts on page 19.

All dimensions and weights are guideline values. Subject to technical modification.

Our deliveries shall be made exclusively in accordance with our currently valid General Terms of Sale.

Layher® 

More Possibilities. The Scaffolding System.

Wilhelm Layher GmbH & Co. KG  
Scaffolding Grandstands Ladders  
Post Box 40  
74361 Gueglingen-Eibensbach  
Germany  
Phone +49 7135 70-0  
Fax +49 7135 70-372  
E-Mail [export@layher.com](mailto:export@layher.com)  
[www.layher.com](http://www.layher.com)