

## LAYHER SOLOTOWER STAIR KIT INSTRUCTIONS FOR ASSEMBLY AND USE

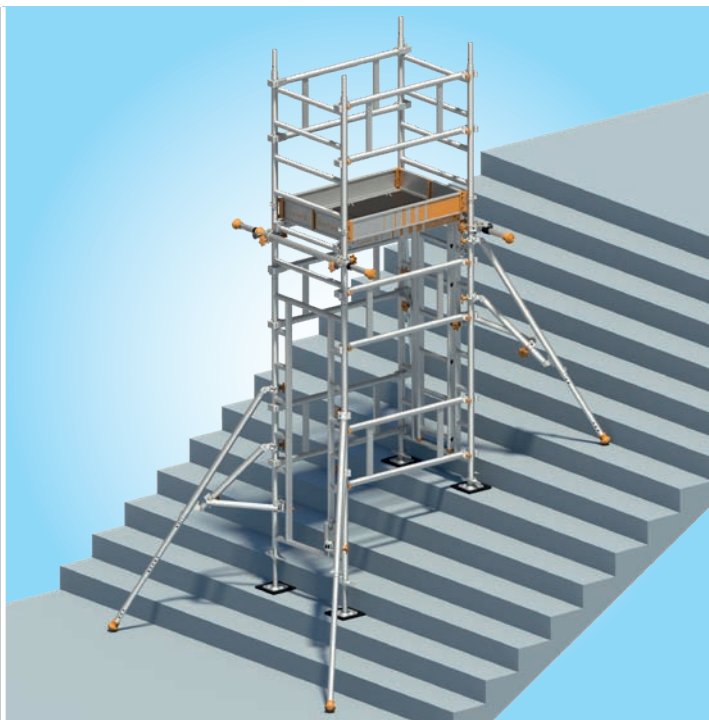

**Edition 11.2020**

Ref. No. 8107.242

### **Expansion**

for assembly on stairs  
of the mobile working platform  
SoloTower



# CONTENTS

1.	Introduction .....	4
2.	General directions for assembly and use.....	4
3.	Measures for fall protection .....	6
4.	Assembly variants for expansion on stairs.....	7
4.1.	Variant 1 .....	7
4.2.	Variant 2 .....	8
4.3.	Variant 3 .....	9
5.	Assembly and dismantling.....	10
5.1	Basic assembly with two walk-through ladder frames .....	11
5.2	Basic assembly with walk-through ladder frame on one side	15
6.	Distance tube attachment .....	19
6.1.	Attachment of tele distance tube 1.25 m.....	19
6.2.	Attachment of tele distance tube 0.50 m.....	19
7.	Stabiliser attachment.....	20
8.	Suspended ladder attachment .....	21
9.	Ballasting.....	22
10.	Parts list.....	26
11.	Components of the system .....	27

## NOTE

The products or assembly variants shown in these instructions for assembly and use may be subject to country-specific regulations. The user of the products bears the responsibility for compliance with these regulations.

Layher recommends that assembly on stairs always be done by at least two persons, to prevent any inadvertent tipping over of the structure or of components of it during assembly.

Subject to local regulations, we reserve the right not to supply all the products illustrated here.

Your Layher partner on the spot will be happy to provide advice and answers to any questions relating to the products, to their use, to specific assembly variants and to current regulations.

# 1. INTRODUCTION

## General

These instructions for assembly and use relate to assembly, modification and dismantling of the expansion for assembly on stairs for the mobile working platform SoloTower made by Wilhelm Layher GmbH & Co KG, of Güglingen-Eibensbach, Germany. These instructions cannot cover all the possible applications. If you have any questions about specific applications, please contact your Layher partner.

**Caution:** The expansion for the Layher SoloTower may only be assembled, modified and dismantled under the supervision of a qualified expert and by technically trained employees.

# 2. GENERAL DIRECTIONS FOR ASSEMBLY AND USE

The expansion for the mobile working platform may be used for the specified scaffolding group in accordance with the stipulations of DIN EN 1004 and taking into account the appropriate sections of the German Ordinance on Industrial Safety and Health (BetrSichV).

**The user of the expansion for the mobile working platform must comply with the following instructions:**

1. The user must verify the suitability of the selected mobile working platform for the work to be performed (Section 4 of BetrSichV).

The ballasting and component requirements in the appropriate sections must be complied with. Non-compliance leads to a risk of accidents, with stability and load-bearing capacity no longer being assured.

If the selected tower cannot be built in the assembly variants described, a separate strength and stability calculation must be conducted for the tower or for individual parts thereof.

2. Assembly, modification or dismantling of the mobile working platform in accordance with the present instructions for assembly and use may only be performed under the supervision of a qualified person or by professionally suitable employees after special instruction. Only the tower models shown in these instructions for assembly and use may be built and also used. The tower must be inspected before, after or during assembly, but no later than before it is put into service (Section 14 of BetrSichV). During assembly, modification or dismantling, the mobile working platform must be marked with a prohibition sign indicating "no entry" (BetrSichV Annex 1, Para. 3).

3. Before installation, all parts must be inspected to ensure they are in flawless condition. Only undamaged original parts of the mobile working platform systems from Layher may be used. Tower parts such as snap-on claws and spigots must be cleaned of dirt after use. The components must be secured against slipping and impacts while being transported. The components must be handled in such a way that they are not damaged.

4. Tools and materials on a small scale must be carried on the person.
5. The ladder frame joints must always be secured using spring clips.
6. Stability must assured during every phase of the assembly process.
7. Upward access to the working platform is permitted only on the inside of the tower.
8. Lifting gear must not be attached to or used on mobile working platforms.
9. Assembly and movement are only permitted on sufficiently firm ground, and only in a longitudinal or diagonal direction. All impacts must be avoided. During movement, normal walking speed must not be exceeded.
10. No personnel and/or loose objects may be on the tower while it is being moved.
11. After movement, the wheels must be locked by operating the brake lever.
- 12 Working on two or more working levels at the same time is not permitted. In the event of exceptions, the manufacturer must be consulted. When work is being done on several levels, they must be completely fitted with 3-part side protection.
13. The mobile working platforms must not be subjected to any aggressive fluids or gases.
14. Mobile working platforms must not be connected to one another by bridging unless the structural strength of that connection has been specifically verified. The same applies for all other special assemblies, e.g. suspended scaffolding etc. Furthermore, it is not permitted to construct bridging between a mobile working platform and a building.
15. If the mobile working platform is used outdoors or in open buildings, it must be moved – when wind strength exceeds 6 on the Beaufort scale or at the end of a shift – into a wind-protected area or safeguarded against tipping over by other suitable measures

**(wind strengths higher than 6 on the scale can be recognised by a noticeable difficulty in walking).** It is recommended that mobile working platforms be anchored if they are left unattended. The maximum permitted tilt is 1 %.

16 Decks may only be repositioned when the specified side protection heights and bracing are complied with. In the event of a design differing from the models shown in the present instructions for assembly and use, the manufacturer must be consulted, as a separate verification of stability may be required.

17. The access hatch must be kept shut whenever it is not in use.

18 Climbing over from one mobile working platform to another or to adjacent buildings is not allowed.

19. Jumping on decked surfaces is not allowed.

20. It must be checked that all parts, auxiliary tools and safety equipment for assembling the mobile working platforms are available at the place of use.

21 Horizontal and vertical loads that can cause the mobile working platform to topple over should be avoided, for example:

- due to pushing against the side protection
- additional wind loads (tunnel effect of through-type buildings, unclad buildings and corners).

22 If stipulated, mobile working platforms must be provided with appropriate base-widening solutions, which can be mobile beams, stabilisers and outriggers. Alternatively, wall bracing or wall clamping arrangements by means of distance tubes can be stipulated.

23 It is not permitted to increase the height of the deck using ladders, boxes or other objects.

24. Mobile working platforms are not designed to be lifted or suspended.

### 3. MEASURES FOR FALL PROTECTION

Assembly on stairs, which do not normally represent a risk of falls, does not require any fall protection. If the stair area should not have any separate fall protection for structural reasons, then fall protection must be assured before assembly.

After assembly of the basic structure (adjustment to stair flight), which should always be done by at least two persons in view of the situation on stairs, further assembly takes place using the **3T method** known from the SoloTower.

#### **Fall protection during assembly, modification or dismantling**

This is the so-called 3T (Through The Trapdoor) method, in which assembly is done through the trapdoor to the next level up by means of the double guardrail, in order to protect against falls.

After climbing up on the inside using the rungs of the ladder frame, the double guardrails are fitted from a sitting position. Once the fall protection has been fitted, the level in question is secure all round and can then be accessed.



## 4. ASSEMBLY VARIANTS FOR EXPANSION ON STAIRS

### 4.1 Variant 1

#### Clamping between the walls

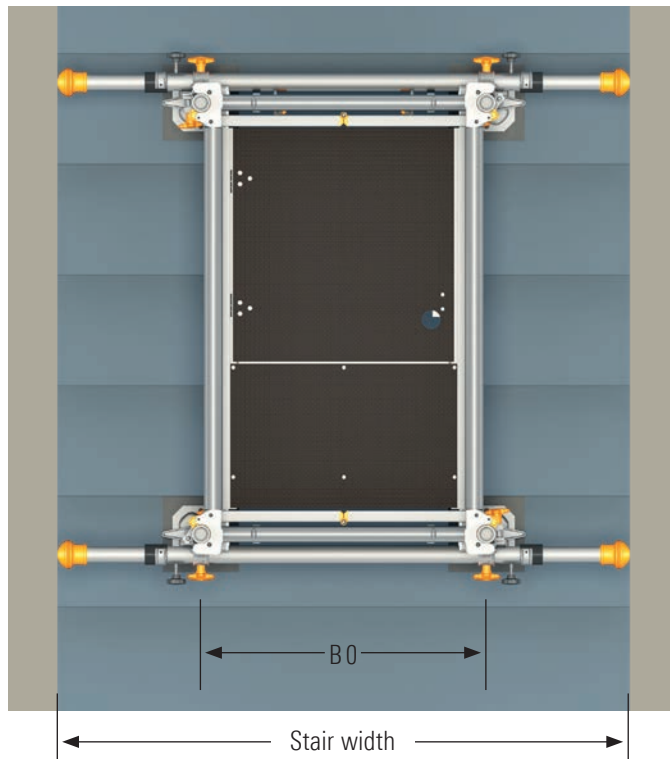

This is an assembly where no support by stabilisers is intended or where they cannot be used effectively.

For assembly of this variant, two sufficiently strong walls are required, between which the structure can be clamped to prevent it tipping over.

The maximum distance between these walls for clamping (stair width) must not exceed 1.9m, and a minimum distance of 0.95m can be implemented using individual distance tubes.

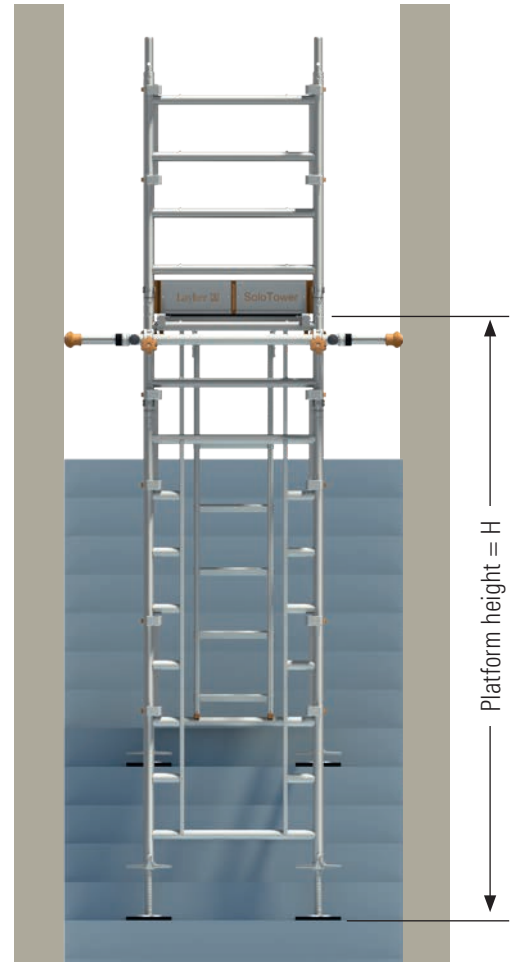

The structure can be put up at the place of use as described in Section 5, Assembly and Dismantling. Clamping using the Tele distance tube 1.25 m **3** or the distance tubes 0.5 m **9** (see p. 19, Section 6, Distance Tube Attachment) must always precede access. Subsequent repositioning of the distance tubes may be required, as these must always be attached underneath the top platform.

By clamping between two walls, ballasting can be dispensed with in Variant 1.

## 4.2 Variant 2

### Wall bracing on one side/stabilisers on one side

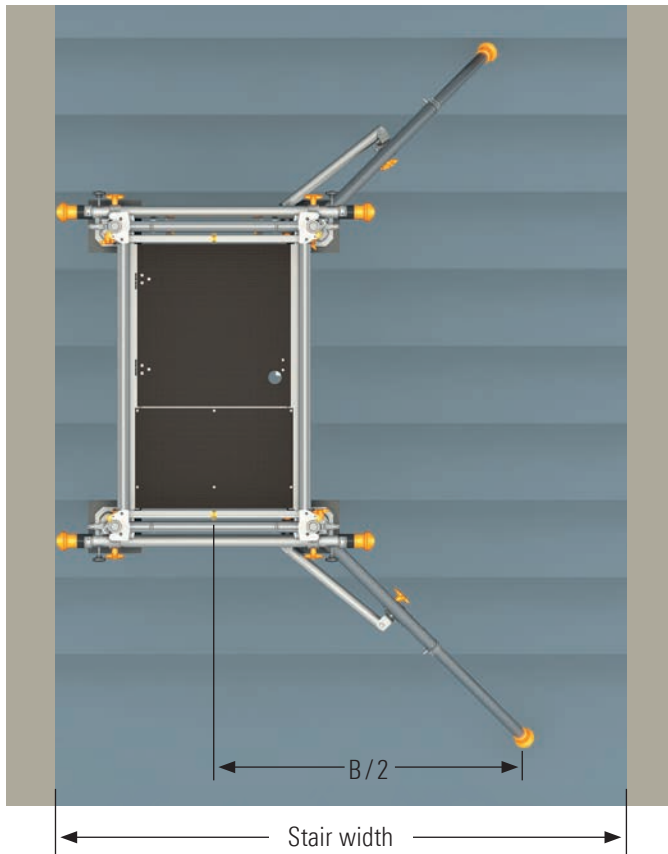

This is an assembly which can be braced on one side against a wall and supported on the opposite side by stabilisers.

Assembly of this variant requires a sufficiently strong wall and enough space to allow attachment of stabilisers on the opposite side to prevent tipping over.

Variant 2 can be used when the appropriate ballasting required for stair widths of 1.25m to >2.5m is allowed for.

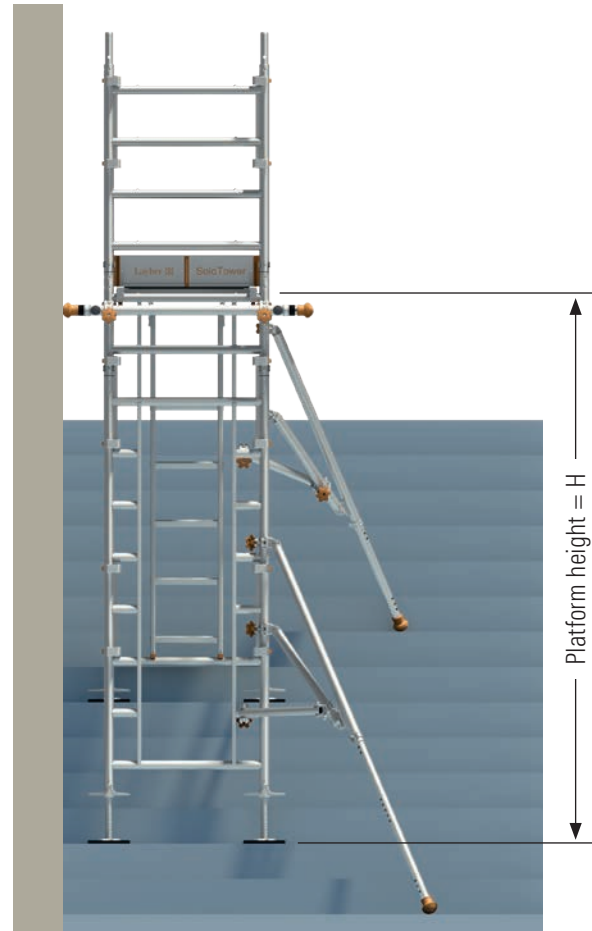

At and above a stair width of >2.6m, no ballasting is required thanks to sufficient outrigger dimensions.

The structure can be put up at the place of use as described in Section 5, Assembly and Dismantling. Wall bracing using the Tele distance tube 1.25m **3** or the distance tubes 0.5m **9** (see p. 19, Section 6, Distance Tube Attachment) must always precede access. Subsequent repositioning of the distance tubes may be required, as these must always be attached underneath the top platform.

The stabilisers too must always be fitted before access.



### 4.3 Variant 3

#### Stabilisers on both sides

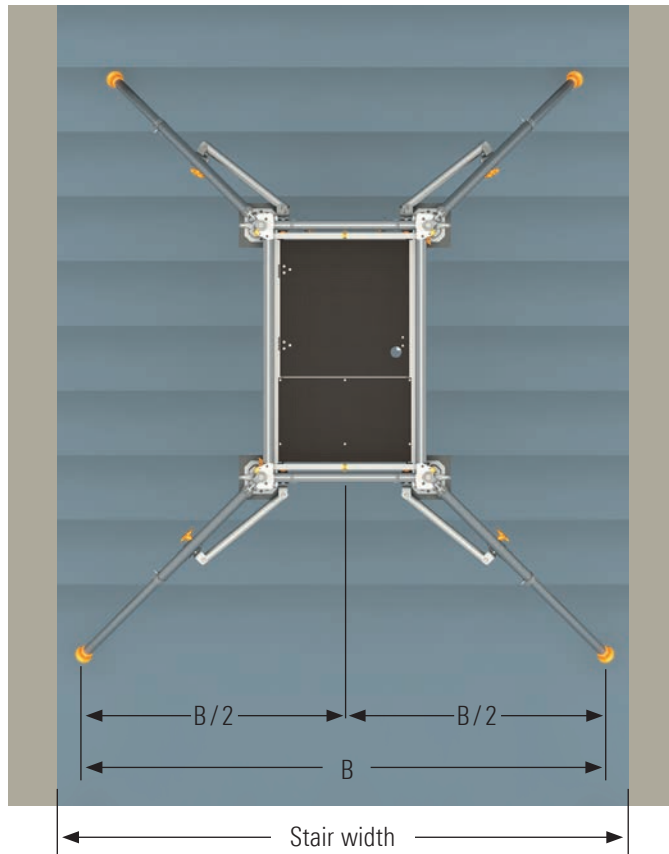

This is an assembly which can be supported by stabilisers on both sides.

Assembly of this variant requires enough space to allow attachment of stabilisers on the both sides to prevent tipping over.

Variant 3 can be used when the appropriate ballasting (see p. 22 of Section 9, Ballasting) required for stair widths of 1.1 m to >2.5 m is allowed for.

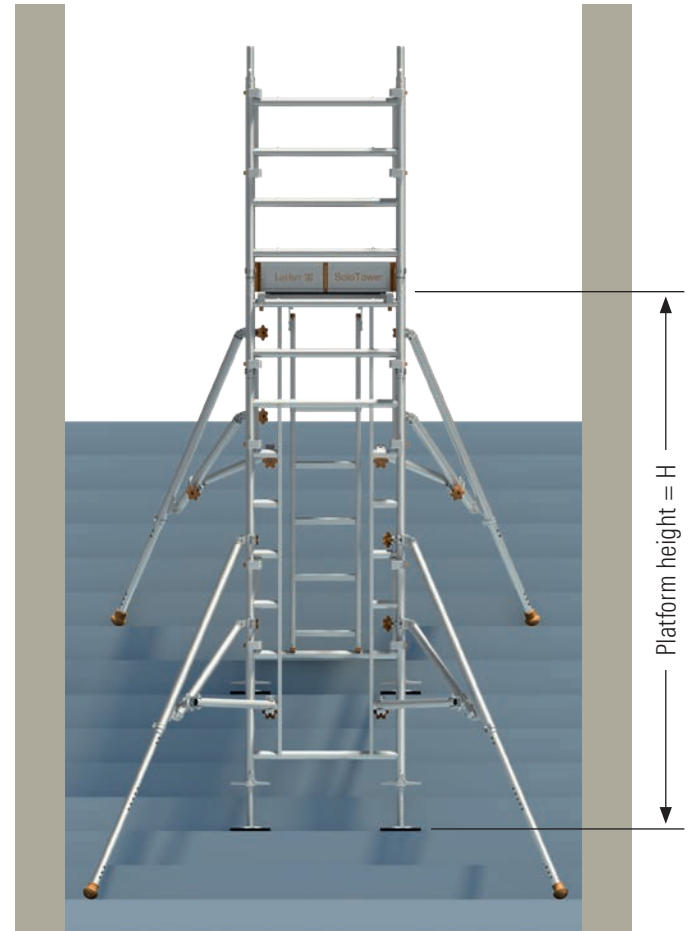

At and above a stair width of >2.6 m, no ballasting is required thanks to sufficient outrigger dimensions.

The structure can be put up at the place of use according to the steps described under Assembly and dismantling.

The stabilisers must always be fitted (see p. 20 of Section 7, Stabiliser Attachment) before access.

## 5. ASSEMBLY AND DISMANTLING

Observe the general directions for assembly and use on pages 4 – 5. The examples shown for assembly are intended for use **in closed areas up to a maximum platform height of 5 metres**. After assembling the expansion on stairs, assembly of the SoloTower following the sequence shown in the instructions for assembly and use of the SoloTower takes place.

**For assembly not covered by the variants shown and for special applications (e.g. assembly outdoors), the manufacturer must be consulted and if necessary a project-related study must be conducted.**

For assembly on stairs it is recommended that the work is always be done by at least two persons, to prevent any inadvertent tipping over of the structure or of components of it during assembly.

Snap the snap-on claws of the decks into the ladder frames from above. Snap in the snap-on claws of the double guardrails from the inside.

Level the tower after basic assembly. This is done using the threads of the adjustable base plates.

Always tighten screw couplers provided with nuts or hand wheels using a suitable wrench or manually (approx. 50 Nm).

If it has to be possible to walk through on the stair, the suspended ladder provided in the walk-through ladder frame (see p. 21, Section 8, Suspended Ladder Attachment) must be used for ascent and descent. To permit walking through, it is possible to remove the ladder in a simple operation to ensure an open passageway on the stair. For descent, it is essential to fit the ladder back in place.

This is only a passageway for site conditions; the required passageway width for escape routes which might be needed cannot be achieved in any way due to the dimensions of the structure.



**If passing through has to be made possible, it must be ensured that a notice is affixed to the structure that warns of the possible tripping hazard resulting from the lower rungs of the walk-through ladder frames when walking on the stair (for example marking with appropriate and readily visible tape/sticker and/or an appropriate warning notice at a readily visible height).**

**The snap-on claws of the double guardrails and access decks, and the spring clips on the ladder frames, must be properly snapped in and then secured.**

On sensitive stair surfaces (e.g. wood, tiles and so on) a complete covering is recommended, or at least the placing of rubber underlays underneath the mounting surfaces of the base plates.

The starting point for information relating to the number of rungs is always the walk-through ladder frame positioned on the lower stair step.

The item numbers **1–10** of the parts in the complete document relate to the section entitled Components of the System on page 27.

### NOTE

**Since these instructions for assembly and use relate to an expansion, the instructions for assembly and use for the SoloTower must always be consulted or followed for the assembly steps following the basic assembly.**

## 5.1 Basic assembly with two walk-through ladder frames

### 5.1.1 Assembly sequence

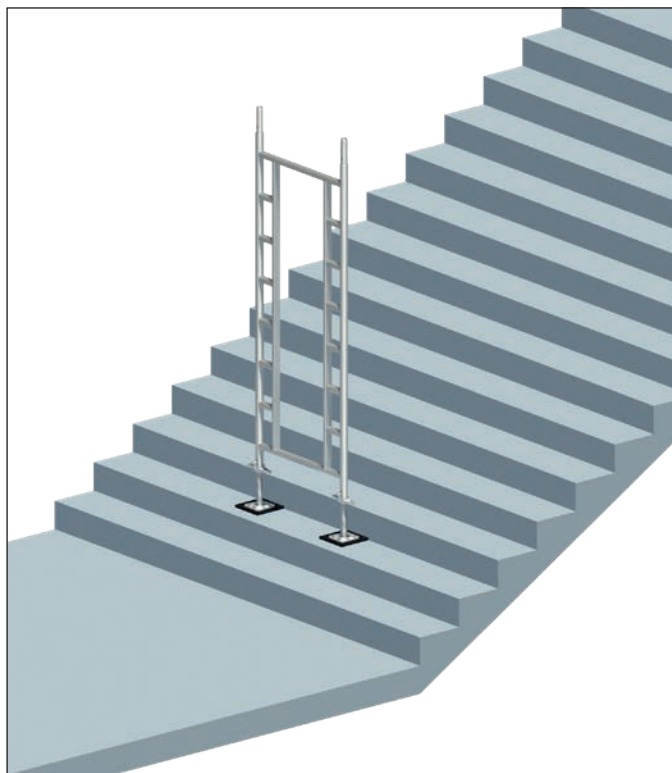

1. Insert two base plates **4** into the walk-through ladder frames **1** and fix them using the locking screw at the appropriate end of the upright.
2. Position the walk-through ladder frame **1** provided with the base plates **4** on one step of the stair. Position the rubber underlay **5**, if the stair surfaces are sensitive, underneath the base plates.

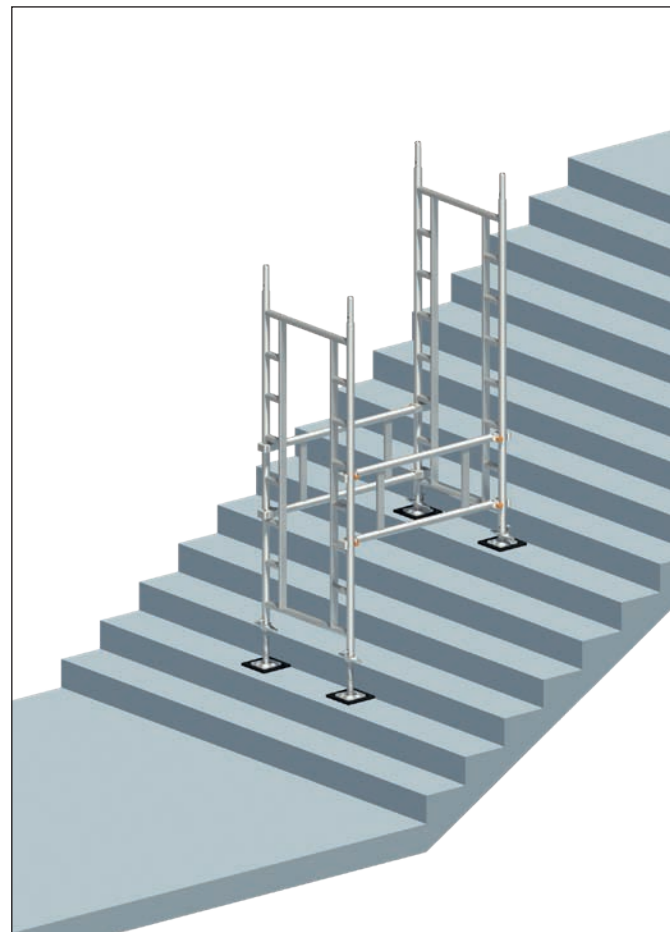

3. Fit two double guardrails on one side between the 3rd and 5th rungs from the bottom.
4. Position the second walk-through ladder frame **1**, into which base plates **4** were also previously inserted and locked. Position the rubber underlay **5**, if the stair surfaces are sensitive, underneath the base plates. Snap in the double guardrails already suspended under 3.
5. Perpendicular alignment of the basic assembly on the corresponding stair steps using the base plates. If the spindle travel is not sufficient, place a load-distributing base centrally underneath the base plate surface with full-surface contact.

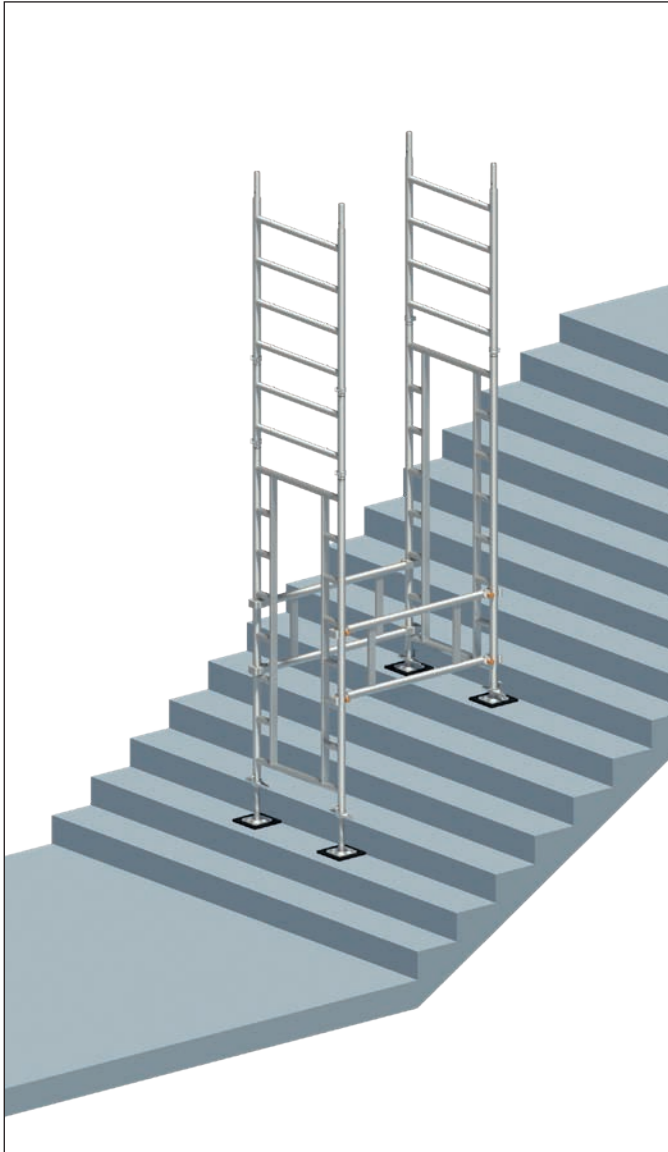

6. Insert a ladder frame 1 m into the spigots provided for the purpose in the upper walk-through ladder frame **1**. Connect the 2-rung ladder frame 0.5 m **2** to a ladder framer 1 m. Place the preassembled unit into the spigots provided for the purpose in the lower walk-through ladder frame **1**.

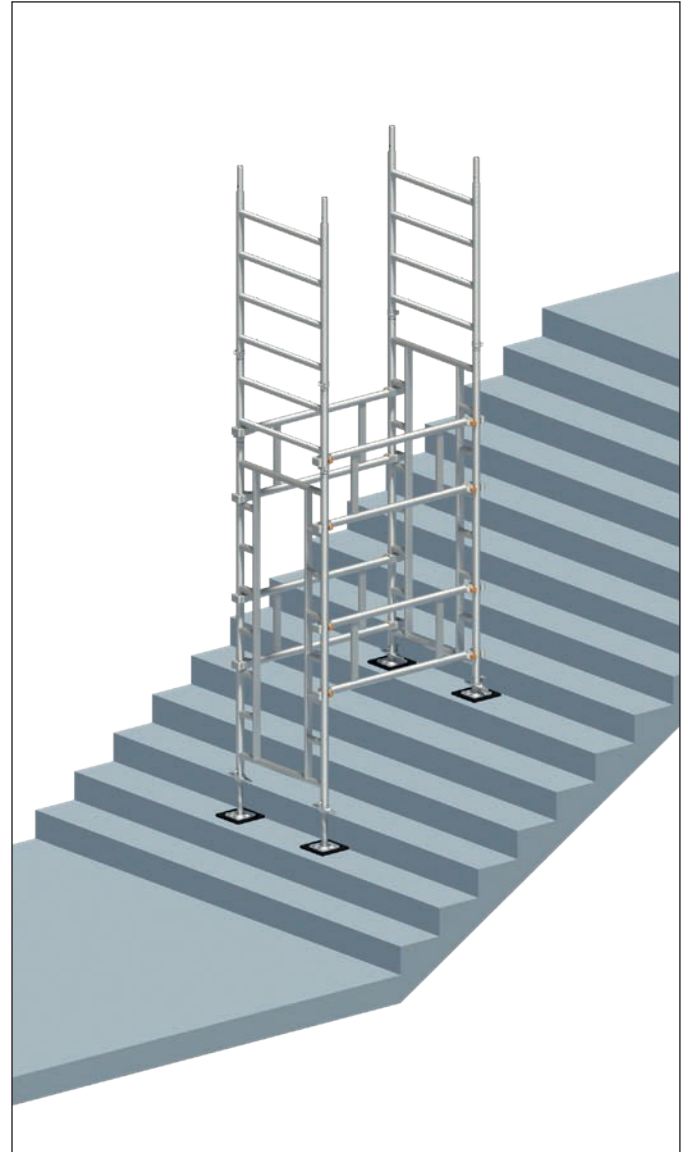

7. Fit two double guardrails between the 7th and 9th rungs from the bottom.



8. Attach the stabilisers (see p. 20, Section 7, Stabiliser Attachment)
9. Suspend the access deck from the 10th rung from the bottom.



10. Fit the suspended ladder **8** (see p. 21, Section 8, Suspended Ladder Attachment) for safer upward access.

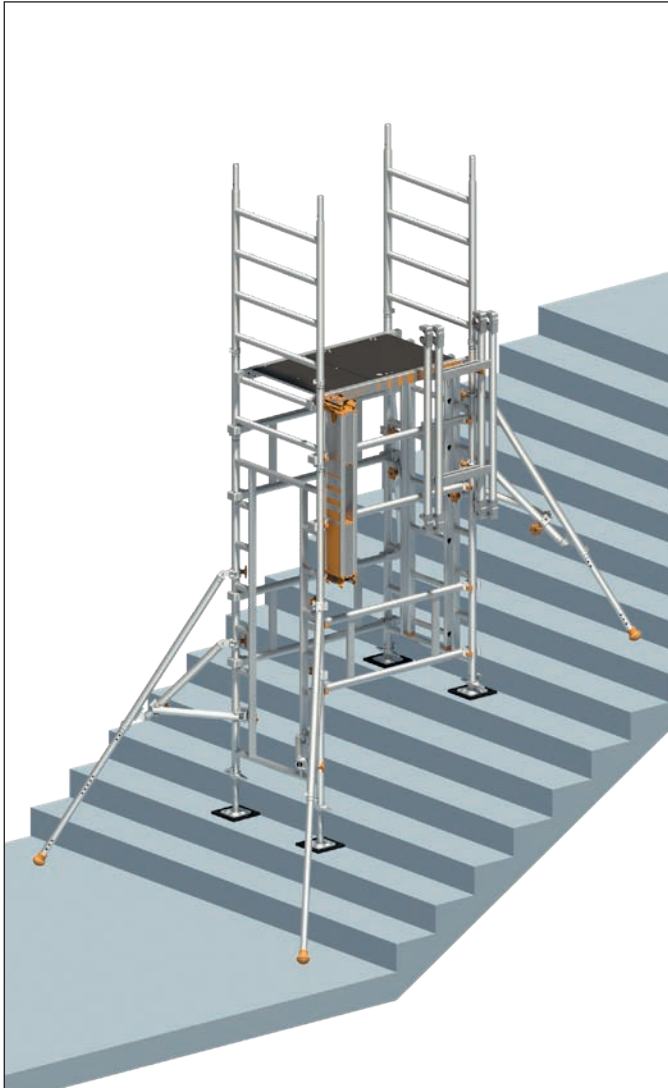

11. Insert a SoloTower assembly hook and position the double guardrails for installation using the 3T method (see instructions for assembly and use of SoloTower).
12. Further assembly depends on the required platform height, following the steps described in the instructions for assembly and use for the SoloTower.



### 5.1.2. Dismantling sequence

The basic assembly with two walk-through ladder frames is dismantled in the reverse order, starting with removal of the double guardrails while using the 3T method.

## 5.2 Basic assembly with walk-through ladder frame on one side

### 5.2.1 Assembly sequence

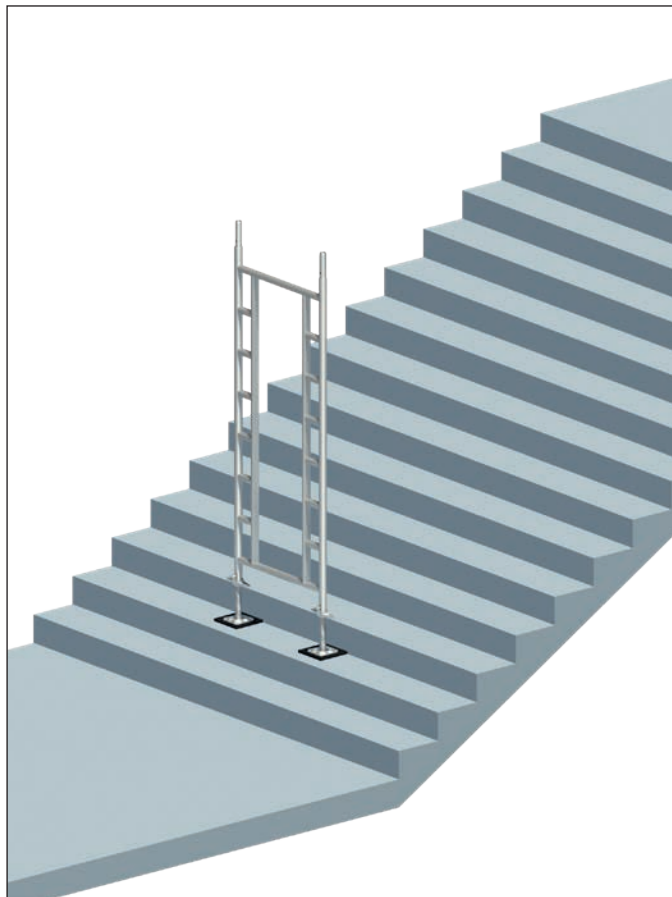

1. Insert two base plates **4** into the walk-through ladder frames **1** and fix them using the locking screw at the appropriate end of the upright.
2. Position the walk-through ladder frames **1** provided with the base plates on one step of the stair. Position the rubber underlay **5**, if the stair surfaces are sensitive, underneath the base plates.

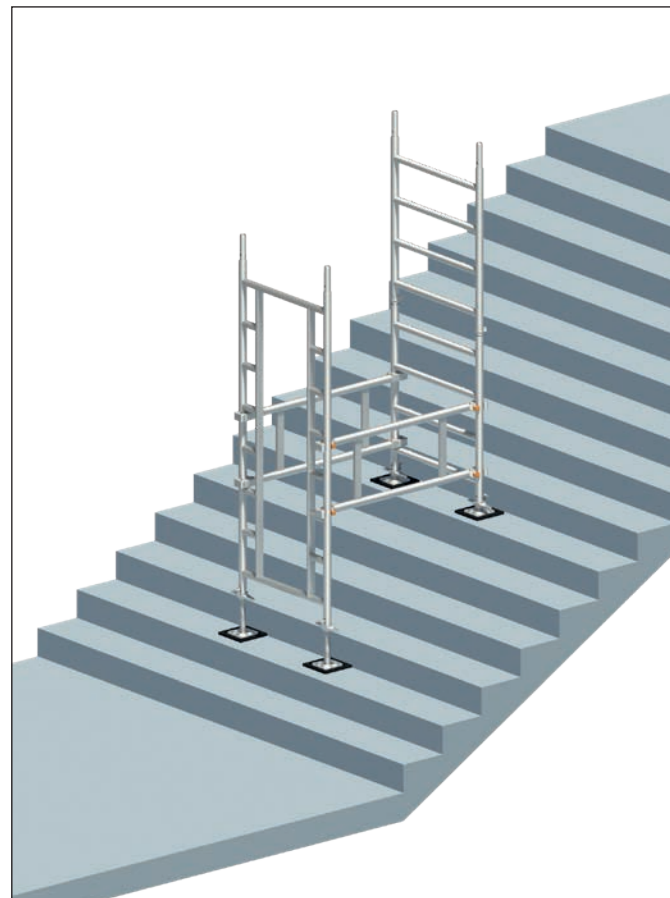

3. Fit two double guardrails on one side between the 3rd and 5th rungs from the bottom.
4. Position two ladder frame **1** m, inserted into one another and secured using spring clips, into which base plates were also previously **4** inserted and locked. Position the rubber underlay **5**, if the stair surfaces are sensitive, underneath the base plates. Snap in the double guardrails already suspended under 3.
5. Perpendicular alignment of the basic assembly on the corresponding stair steps using the base plates. If the spindle travel is not sufficient, place a load-distributing base centrally underneath the base plate surface with full-surface contact.

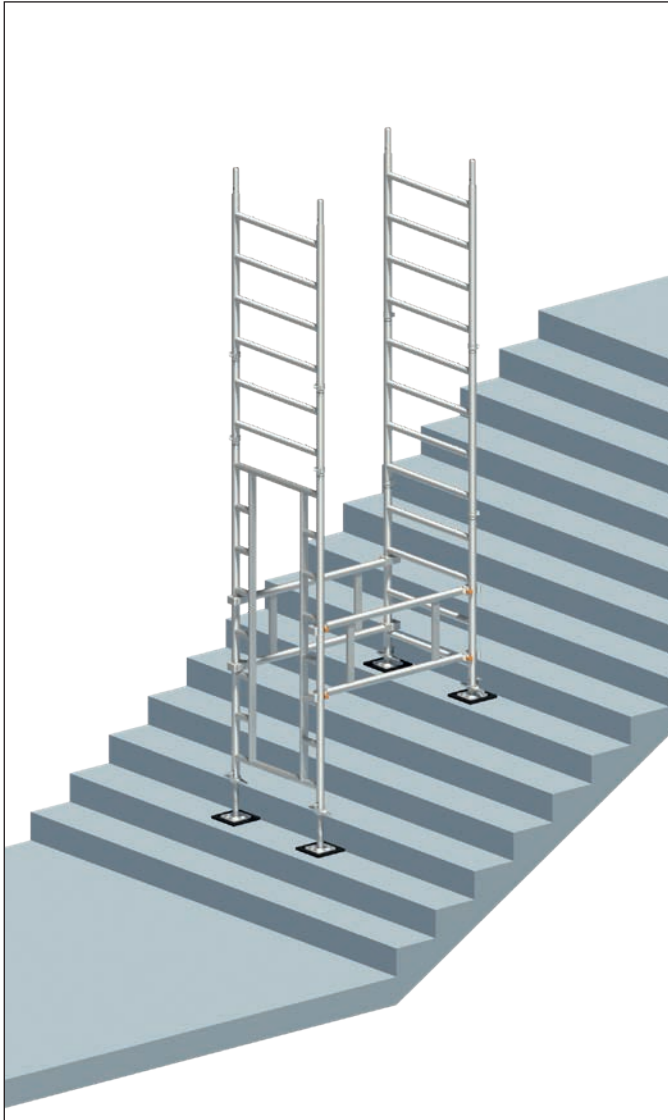

6. Place a ladder frame 1 m into the spigots provided for the purpose in the upper rung ladder frame 1 m. Connect the 2-rung ladder frame 0.5 m **2** to a ladder framer 1 m, place the preassembled unit into the spigots provided for the purpose in the walk-through ladder frame **1**.

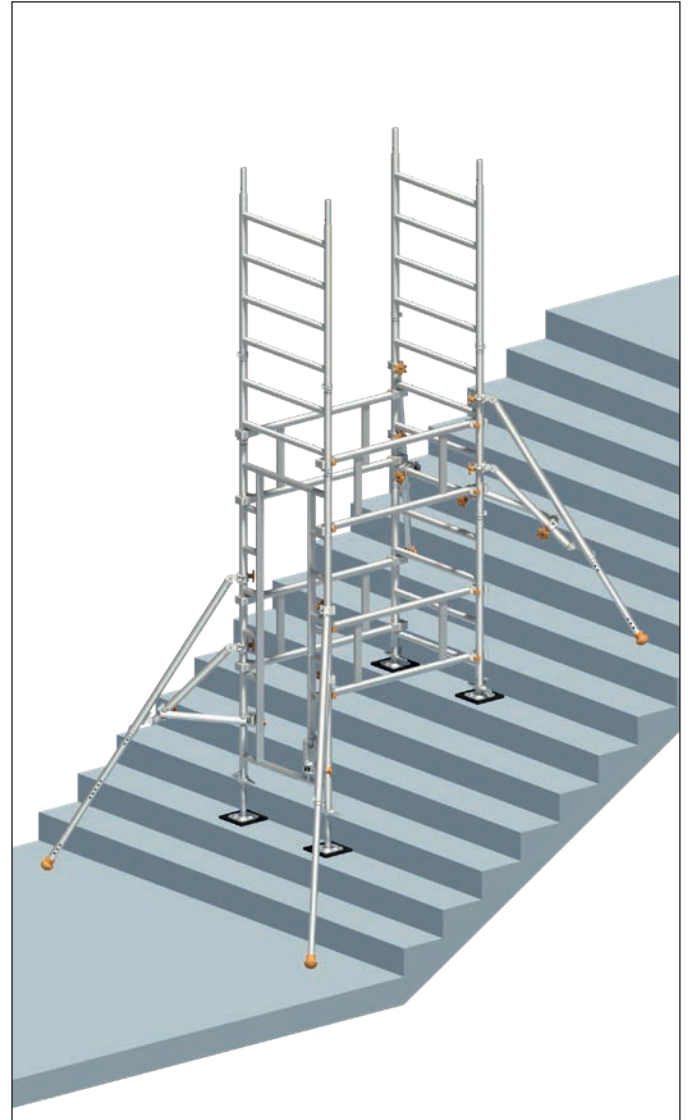

7. Fit two double guardrails between the 7th and 9th rungs from the bottom.





8. Attach the stabilisers (see p. 20, Section 7, Stabiliser Attachment)
9. Suspend the access deck from the 10th rung from the bottom.

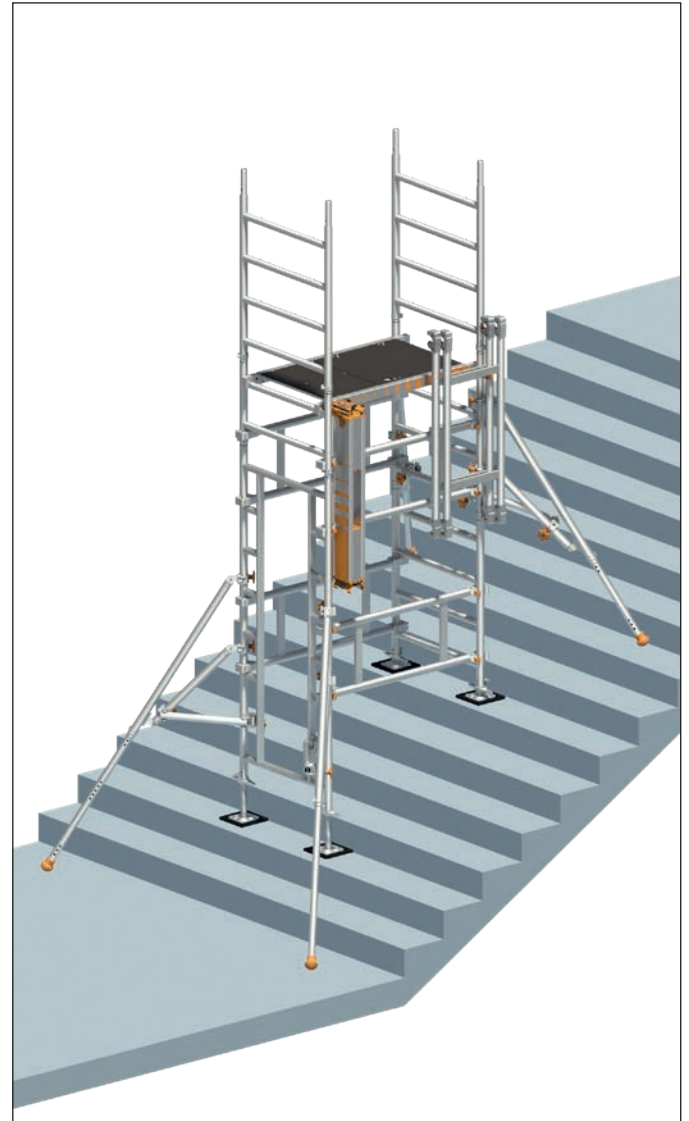

10. Insert a SoloTower assembly hook and position the double guardrails for installation using the 3T method (see instructions for assembly and use of SoloTower).
11. Further assembly depends on the required platform height, following the steps described in the instructions for assembly and use for the SoloTower.



### 5.2.2. Dismantling sequence

The basic assembly with one walk-through ladder frame is dismantled in the reverse order, starting with removal of the double guardrails while using the 3T method.

## 6. DISTANCE TUBE ATTACHMENT

The distance tubes mentioned in these instructions

- Tele distance tube 1.25 m **3**
- Distance tube 0.50 m **9**

are fastened to the upright tubes of the ladder frames using scaffolding couplers, which must be equipped with handwheels for tool-free fitting.

After appropriate positioning, tighten the couplers firmly.

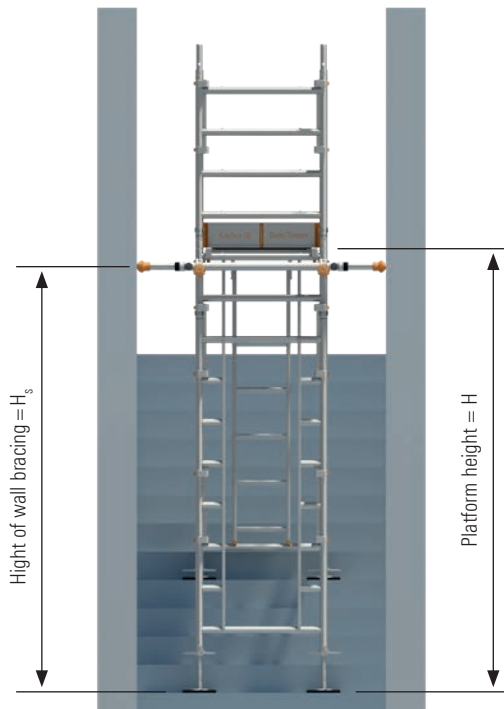

For height positioning, the ratio between the platform height  $H$  and the height of the wall bracing  $H_s$  must not undercut the value 1.5.

Example:  $H = 3 \text{ m} / H_s = 2 \text{ m}$        $R: 3 / 2 = 1.5$       ✓  
 $H = 3 \text{ m} / H_s = 1.5 \text{ m}$        $R: 3 / 1.5 = 2$       ✗

### 6.1. Attachment of Tele distance tube 1.25 m



The distance tube **3** telescoping on both sides can, after fastening to the upright tubes using scaffolding couplers, be extended by undoing the knurled screw and resting it on the wall at the appropriate points with the rubber foot provided for the purpose.

### 6.2 Attachment of distance tube 0.50 m



For contact with the wall, undo the scaffolding couplers far enough to allow shifting and positioning of the rubber foot intended for the purpose, and then retighten the scaffolding couplers.

## 7. STABILISER ATTACHMENT

For the model with stabilisers described in these instructions, a stabiliser including a rotation lock is required on each upright of the ladder frame to ensure stability of the tower.

Base-widening devices such as stabilisers should generally speaking always be attached before the tower is accessed to prevent the structure from tipping over.

For assembly, position the first half-coupler on the upright tube of the ladder frame (**do not tighten yet**) such that the stabiliser at its maximum possible extension can be placed firmly on a stair step, the floor in front of the stair or a stair landing. Once the half-coupler is positioned, temporarily remove the spring clip, allowing the telescoping tube to be extended to the required length and then secured in a congruent hole by reinserting the spring clip. Move the positioned half-coupler along the upright tube to bring the stabiliser to the right position, so that the rubber foot at the end of the stabiliser is in firm contact with the ground.

The transverse tube of the stabiliser can now be fastened to the upright tube with the second half-coupler, while ensuring that the rubber foot always remains in contact with the ground to provide the required support.

After aligning the stabilisers, tighten all the half-couplers using the hand wheel. Then safeguard the stabiliser against inadvertent rotation using the rotation lock provided.

The position or the angle must always be set to the maximum dimension, depending on the stairs – at and above a stair width of 2.90 m the stabilisers must be generally set to 45° relative to the longitudinal side of the tower.

It is essential to ensure that the rubber foot of the stabiliser is always in firm contact with the floor and not positioned on the edge, to prevent any inadvertent slippage. If this cannot be assured, a sufficiently strong load-distributing base must be provided.

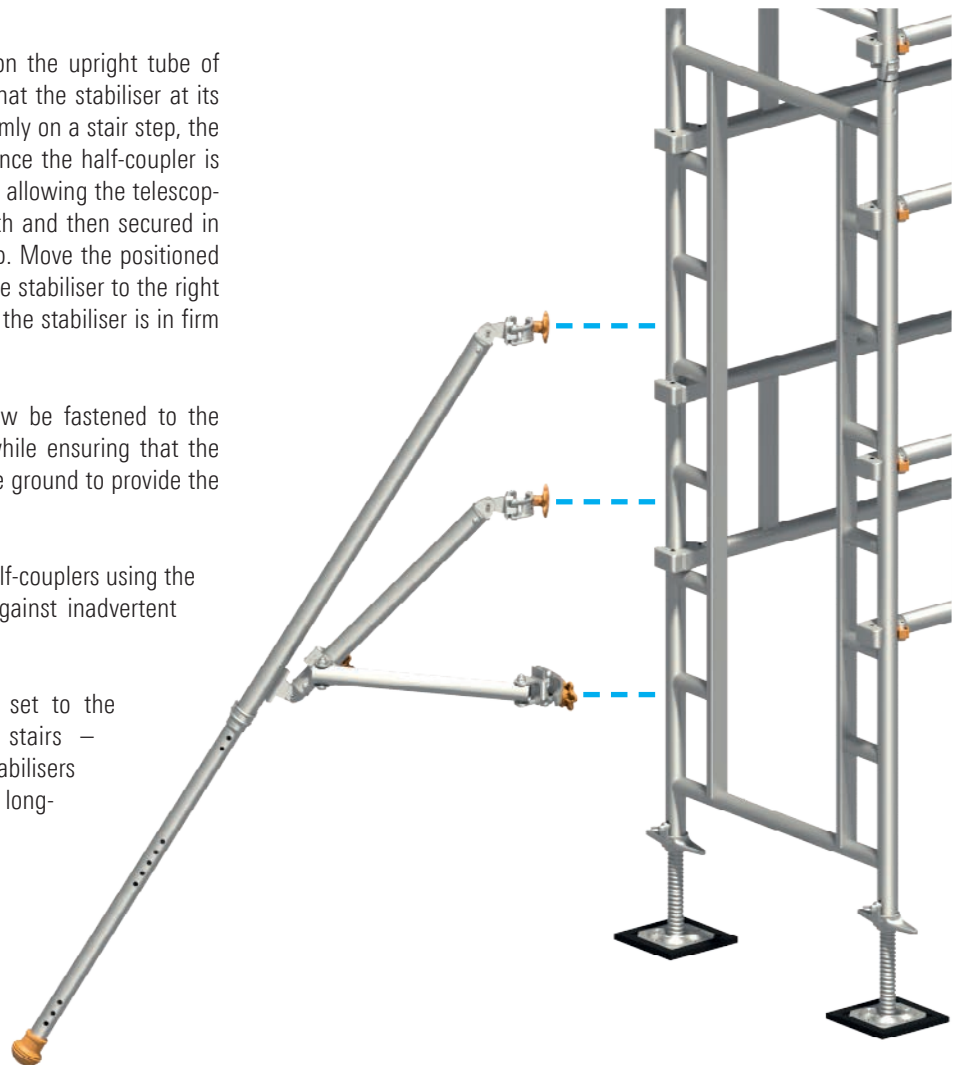

## 8. SUSPENDED LADDER ATTACHMENT

The suspended ladder **8** mentioned in these instructions ensures safer upward access when two walk-through ladder frames **1** are used. To ensure a sure footing when climbing up into the structure, the suspended ladder must be fitted before doing so.



### 8.1. Assembly and dismantling

By opening the drop latch at the suspension hook of the ladder, it can be suspended in the top rung of the walk-through ladder frame **1**. By attaching the ladder end to the bottom rung of the walk-through ladder frame **1**, it permits vertical access, as is usual in mobile working platforms, up into the structure.

To remove the ladder, the drop latch is again opened and the ladder can be lifted out again.

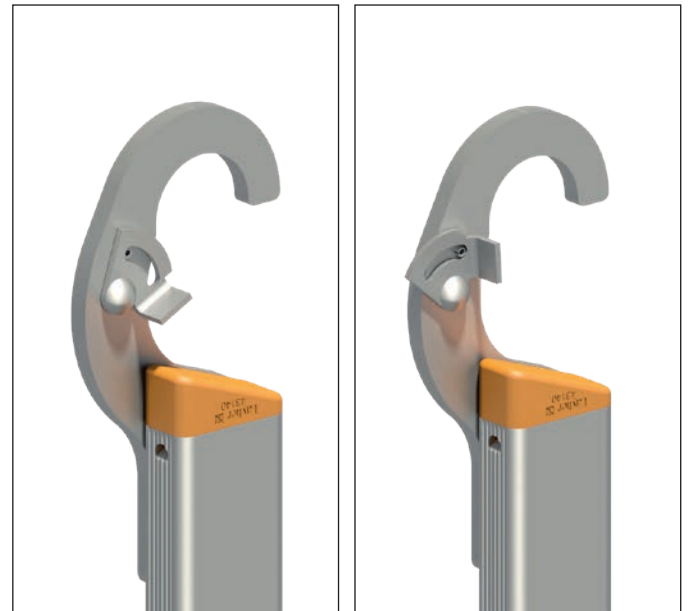

In the event that a passageway is needed in the stairwell, the suspended ladder can be detached, during work on the tower and after access, and pulled upwards. This provides in the area of the walk-through ladder frames **1** a passageway on the stair.

This is only a passageway for site conditions; the required passageway width for escape routes which might be needed cannot be achieved in any way due to the dimensions of the structure.

## 9. BALLASTING

For ballasting, use Layher ballast weights **10** of 10 kg each. Couplers with hand wheels permit simple, quick and secure fixing of the ballast required at the correct places. As a general principle, only ballast weights of solid materials may be used (not liquid or granular materials).

The ballast weights must as a general principle be fastened as far down as possible to the uprights of the ladder frame. Their number and positions are shown in the illustrations and tables on the following pages.

Depending on the assembly variant and the number of ballast weights needed, it may be necessary to provide additional fastening points. This can for example be done using scaffolding tubes and scaffolding couplers.

### Attachment of ballast weights

Example:  
Platform height  $H = 5\text{ m}$   
Outrigger width  $B = 1.8 - 2\text{ m}$

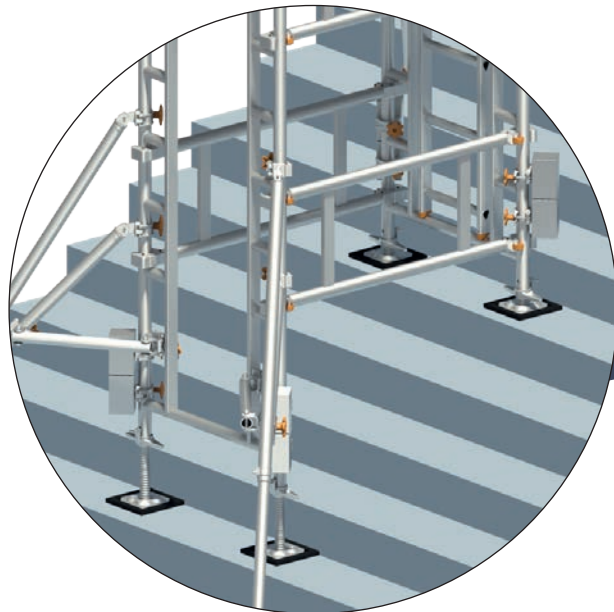

## Ballasting in Variant 1

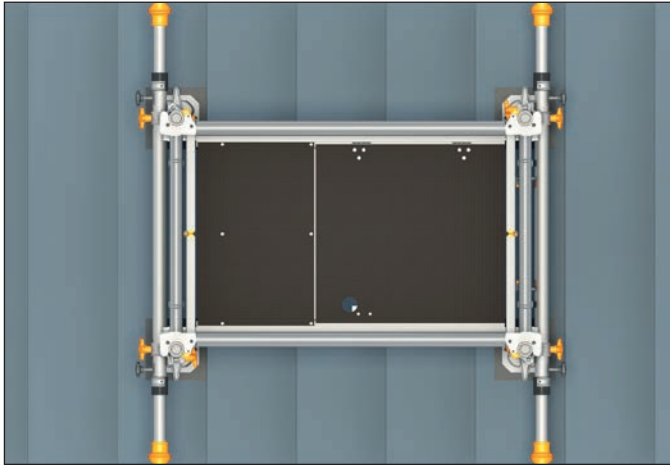

**For Variant 1 no ballast is required!**

## Ballasting in Variant 2

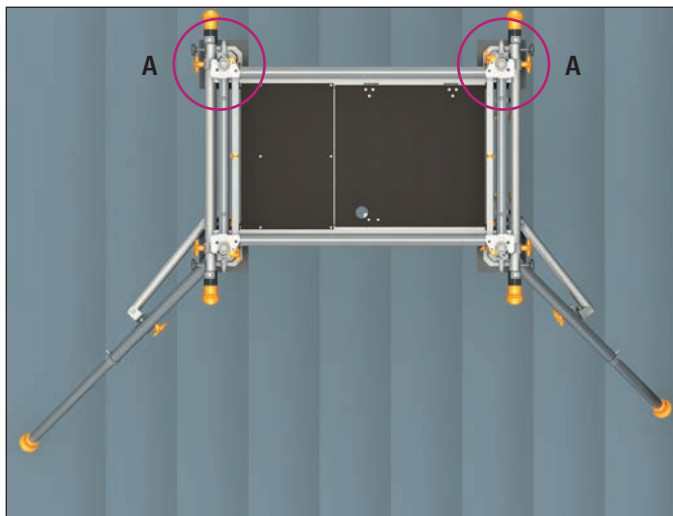

## Ballasting table for Variant 2

Stabilisers		Variant 2					
		H = 3 m		H = 4 m		H = 5 m	
Outrigger width (B) [m]	Stair width [m]	No of ballast weights per point A [pcs.]	Total ballast per model [pcs.]	No of ballast weights per point A [pcs.]	Total ballast per model [pcs.]	No of ballast weights per point A [pcs.]	Total ballast per model [pcs.]
1.1	1.2	4	8	6	12	8	16
1.2	1.3	3	6	5	10	7	14
1.3	1.4	3	6	5	10	6	12
1.4	1.5	2	4	4	8	5	10
1.5	1.6	2	4	3	6	5	10
1.6	1.7	2	4	3	6	4	8
1.7	1.8	1	2	3	6	4	8
1.8	1.9	1	2	2	4	3	6
1.9	2.0	–	–	3	6	3	6
2.0	2.1	–	–	2	4	2	4
2.1	2.2	–	–	2	4	2	4
2.2	2.3	–	–	1	2	1	2
2.3	2.4	–	–	1	2	1	2
2.4	2.5	–	–	1	2	1	2
2.5	2.6	–	–	–	–	–	–

At and above an outrigger width of 2.50 m, ballast is no longer required.



## Ballasting in Variant 3

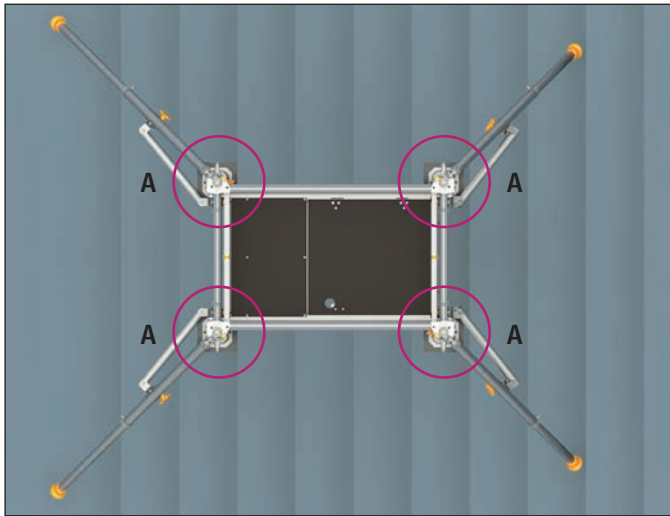

## Ballasting table for Variant 3

Stabilisers		Variant 2					
		H = 3 m		H = 4 m		H = 5 m	
Outrigger width (B) [m]	Stair width [m]	No of ballast weights per point A [pcs.]	Total ballast per model [pcs.]	No of ballast weights per point A [pcs.]	Total ballast per model [pcs.]	No of ballast weights per point A [pcs.]	Total ballast per model [pcs.]
1.1	1.2	3	12	5	20	7	28
1.2	1.3	3	12	4	16	6	24
1.3	1.4	2	8	4	16	5	20
1.4	1.5	2	8	3	12	4	16
1.5	1.6	2	8	3	12	4	16
1.6	1.7	1	4	2	8	3	12
1.7	1.8	1	4	2	8	3	12
1.8	1.9	1	4	2	8	2	8
1.9	2.0	–	–	2	8	2	8
2.0	2.1	–	–	2	8	2	8
2.1	2.2	–	–	1	4	1	4
2.2	2.3	–	–	1	4	1	4
2.3	2.4	–	–	1	4	1	4
2.4	2.5	–	–	1	4	1	4
2.5	2.6	–	–	–	–	–	–

At and above an outrigger width of 2.50 m, ballast is no longer required.

## 10. PART LIST

	Item description	Reference No.	SoloTower Stair Kit		
			1600.002	1600.003	1600.004
1	Walk-through ladder frame 75/8 rung	1296.008	1	2	2
2	Ladder frame 75/2 rung	1297.002	1	1	1
3	Tele distance tube 1.25 m	1275.001	2	2	2
4	Adjustable base plate 60 with lock	1257.060	4	4	4
5	Rubber underlay for base plate	4000.500	4	4	4
6	Double coupler SW 19 mm	4700.019	4	4	4
7	Hand wheel with bush	6491.422	8	8	8
8	Suspended ladder for walk-through ladder frame	1247.006	0	0	1
Alternatively		Reference No.	1600.002	1600.003	1600.004
9	Distance tube 0.5 m	1275.050	4	4	4
10	Ballast	1249.000	see Table "Ballasting"		

### NOTE

Since these instructions for assembly and use relate to an expansion, the instructions for assembly and use for the SoloTower must always be consulted or followed for the assembly steps following the basic assembly.

## 11. COMPONENTS OF THE SYSTEM

1



**1296.008 Walk-through ladder frame 75/8**

aluminium  
rungs with non-slip grooving  
with walk-through opening  
width 75 cm

2



**1297.002 Ladder frame 75/2**

aluminium  
rungs with non-slip grooving  
width 75 cm

3



**1275.001 Tele distance tube 1.25 m**

telescoping  
aluminium, with rubber foot

4



**1257.060 Adjustable base plate 60 with lock**

steel, galvanized  
spindle extension max. 0.4 m

5

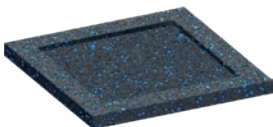

**4000.500 Rubber underlay for base plate**

6



**4700.019 Double coupler AF 19**  
steel, galvanized

7



**6491.422 Hand wheel with bush**

8



**1247.006 Suspended ladder for walk-through ladder frame**  
aluminium

9



**1275.050 Distance tube 0.5 m**  
aluminium  
with rubber foot

10



**1249.000 Ballast (10 kg)**  
steel  
hot-dip-galvanized  
with half-coupler



**Layher**® 

More Possibilities. The Scaffolding System.

**Wilhelm Layher GmbH & Co KG**  
Scaffolding Grandstands ladders

Ochsenbacher Strasse 56  
74363 Gueglingen-Eibensbach  
Germany

Post box 40  
74361 Gueglingen-Eibensbach  
Germany  
Phone +49 (0)71 35 70-0  
Fax +49 (0)71 35 70-2 65  
E-Mail [info@layher.com](mailto:info@layher.com)  
[www.layher.com](http://www.layher.com)

